

FOR CAR USE ONLY/NUR FÜR AUTOMOBIL GEBRAUCH/POUR APPLICATION AUTOMOBILE/PARA USO EN AUTOMÓVILES/SOLO PER L'UTILIZZO IN AUTOMOBILE/ENDAST FÖR BILBRUK



Mobile Media Station

IVA-W205R IVA-W202R



MP3



- **OWNER'S MANUAL**
Please read before using this equipment.
- **BEDIENUNGSANLEITUNG**
Lesen Sie diese Bedienungsanleitung bitte vor Gebrauch des Gerätes.
- **MODE D'EMPLOI**
Veuillez lire avant d'utiliser cet appareil.
- **MANUAL DE OPERACIÓN**
Léalo antes de utilizar este equipo.
- **ISTRUZIONI PER L'USO**
Si prega di leggere prima di utilizzare l'attrezzatura.
- **ANVÄNDARHANDLEDNING**
Innan du använder utrustningen bör du läsa igenom denna användarhandledning.

ALPINE ELECTRONICS MARKETING, INC.
1-1-8 Nishi Gotanda,
Shinagawa-ku,
Tokyo 141-0031, Japan
Phone 03-5496-8231

ALPINE ELECTRONICS OF AMERICA, INC.
19145 Gramercy Place, Torrance,
California 90501, U.S.A.
Phone 1-800-ALPINE-1 (1-800-257-4631)

ALPINE ELECTRONICS OF CANADA, INC.
777 Superstest Road, Toronto,
Ontario M3J 2M9, Canada
Phone 1-800-ALPINE-1 (1-800-257-4631)

ALPINE ELECTRONICS OF AUSTRALIA PTY. LTD.
161-165 Princes Highway, Hallam
Victoria 3803, Australia
Phone 03-8787-1200

ALPINE ELECTRONICS GmbH
Frankfurter Ring 117, 80807 München, Germany
Phone 089-32 42 640

ALPINE ELECTRONICS OF U.K. LTD.
Alpine House
Fletchamstead Highway, Coventry CV4 9TW, U.K.
Phone 0870-33 33 763

ALPINE ELECTRONICS FRANCE S.A.R.L.
(RCS PONTOISE B 338 101 280)
98, Rue de la Belle Etoile, Z.I. Paris Nord II,
B.P. 50016, 95945 Roissy Charles de Gaulle
Cedex, France
Phone 01-48638989

ALPINE ITALIA S.p.A.
Viale C. Colombo 8, 20090 Trezzano
Sul Naviglio (MI), Italy
Phone 02-484781

ALPINE ELECTRONICS DE ESPAÑA, S.A.
Portal de Gamarra 36, Pabellón, 32
01013 Vitoria (Alava)-APDO 133, Spain
Phone 945-283588

ALPINE ELECTRONICS (BENELUX) GmbH
Leuvensesteenweg 510-B6,
1930 Zaventem, Belgium
Phone 02-725-13 15

EN

DE

FR

ES

IT

SE

Contents

Operating Instructions

WARNING

WARNING	4
CAUTION	4
PRECAUTIONS	5
Discs Playable on This Unit	6

Getting Started

Accessory List	9
Location of Controls	9
Turning Power On or Off	9
Inserting/Ejecting a Disc	10
Adjusting the Monitor Viewing Angle	10
Adjusting the Volume	10
How to view the Display	11
Touchscreen operation	11
Recalling the Source	11
Displaying the Numeric Keypad Input Screen	12

Radio

Listening to the Radio	12
Presetting Stations Manually	13
Presetting Stations Automatically	13
Tuning to Preset Stations	13

RDS Operation

Turning AF (Alternative Frequencies) On or Off	13
Receiving Traffic Information	14
PTY (Programme Type) Tuning	14
Receiving Traffic Information While Playing CD or Radio	14
Priority News	14
Displaying Radio Text	14

CD/MP3/WMA

Playback	15
Repeat Play	16
M.I.X. (Random Play)	16
Selecting Folders (concerning MP3/WMA) ...	16
About MP3/WMA	16

DVD/Video CD

Playing a Disc	18
To display the DVD mode screen	18
If a menu screen appears	19
Displaying the Top Menu Screen	20
Displaying the Menu Screen	20
Displaying the Menu Operation Mode Screen	20
Searching by Programme	20
Searching by Playlist	20
Stopping Playback (PRE STOP)	21
Stopping Playback	21
Fast-forward/Fast-reverse	21
Finding the Beginnings of Chapters or Tracks	21
Playing Still Frames (Pausing)	21
Forward/reverse frame-by-frame Playback	21
Slow Motion Playback	22
Selecting Programme (SKIP)	22
Selecting Playlist (SKIP)	22
Repeat Playback	22
Searching by Title/Group/Programme/ Playlist Number	23
Searching Directly by Chapter or Track Number	23
Switching the Angle	24
Scroll to Move the Page Forward or Back	24
Switching the Audio Tracks	24
Switching the Subtitles (Subsubtitle Language)	25
Switching from the disc menu	25
Displaying the Disc Status for DVD/Video CD	25

Other Useful Features

Adjusting the Audio (Adjust the Fader/Balance/Defeat/NAV. Level/Subwoofer/H.P.F./Bass/Treble/Loudness)	26
Search Function	27
Rear Entertainment Function	27
Switching Display Modes	28
Switching the Visual Source Only (Visual Select)	28
Cancelling the Visual Select Function	28
Blackout Mode On and Off	28

Setup

DVD Setup

DVD Setup Operation	29
Setting of the Menu Language	29
Setting of the Audio Language	29
Setting of the Subtitle Language	30
Changing the Country Code Setting	30
Setting the Rating Level (Parental Lock)	30
Changing the Digital Output Setting	30
Setting the Downmix Mode	32
Setting the TV Screen Setting	32
Setting of the Bonus Code	32
Setting of the DVD-Audio Playback Mode	32
Playing MP3/WMA Data (File Play Mode)	33
Setting the Video CD Play Mode	33

RADIO Setup

Radio Setup Operation	33
RDS Time Display	33
Adjusting Source Signal Levels	33
PI SEEK Setting	33
Receiving RDS Regional (Local) Stations	33
Switching the Display Language of PTY (Programme Type)	33
Setting PTY31 (Emergency Broadcast) Reception	33

GENERAL Setup

General Setup Operation	34
Displaying the Time	34
Setting the Time	34
Setting Daylight Saving Time	34
Demonstration Function	34
Sound (Beep) Guide Function	34
Setting the Scroll	34
Switching to the Russian Font	34

Adjusting the Dimmer of Button Lighting at Night	35
---	----

SYSTEM Setup

System Setup Operation	35
Setting the External Device Interrupt Mode	35
Setting the Interrupt Icon Display	35
Switching the function of the remote sensor	35
Setting the Rear Camera Input	36
Setting the Navigation Mode	36
Setting the Navigation Interruption	36
Setting the AUX Mode	36
Adjusting the External Input Audio Level	36
Switching the Visual Input Signal System	36
Setting the Picture Output	36
Setting the Bluetooth Connection (BLUETOOTH IN)	37
Setting the USB Adapter (KCA-620M) to ON/OFF	37
Setting the VISUAL Soft Button	37
Setting the Digital Output	37
Subwoofer On and Off	37

DISPLAY Setup

Display Setup Operation	37
Setting the Brightness of the Backlighting	38
Adjusting the Minimum Level of Backlight	38
Switching Background Textures	38
Setting Automatic Wallpapers	38
Switching the Font Back Display Colour ...	38
Turning the Touch Panel Vibration ON or OFF	38
Adjusting the Touch Panel	38

VISUAL EQ™

Visual EQ Setting Operation	39
Selecting the VISUAL EQ Mode (Maker's setting)	39
Adjusting Brightness	39
Adjusting Colour of Picture	39
Adjusting Tint of Picture	40
Adjusting Image Contrast	40
Adjusting Picture Quality	40
Storing VISUAL EQ	40

Data Download

Downloading the BACKGROUND data	40
---------------------------------------	----

Connection of an External Device

External Audio Processor (Optional)

Adjustment Procedure for Dolby Surround ...	41
Setting the Speakers	42
Set MX Mode of the External Audio Processor	42
X-OVER Adjustment	43
Performing Time Correction Manually (TCR)	43
Phase Switching	44
Graphic Equalizer Adjustments	44
Parametric Equalizer Adjustments	45
Setting Bass Sound Control	46
Setting Bass Compressor	46
Setting Bass Focus	46
Speaker Setup	46
Setting of Dolby Digital	47
Adjusting the acoustic image (BI-PHANTOM)	47
Mixing bass sound to the rear channel (REAR MIX)	47
Achieving powerful high volume sound (LISTENING MODE)	47
Adjusting the speaker levels (OUTPUT LEVEL)	47
Adjusting the DVD Level	48
Storing Settings in the Memory	48
Calling up the Preset Memory	48
Using the Pro Logic II Mode	48
Linear PCM Setting	49

Navigation System (Optional)

Switching the Navigation Screen (Optional)	49
Portable Navigation System Operation (Optional)	49

Auxiliary Device (Optional)

Operating Auxiliary Devices (Optional)	50
--	----

TUE-T200DVB Operation (Optional)

Operating the TUE-T200DVB (Optional)	51
--	----

Changer (Optional)

Controlling CD Changer (Optional)	51
Multi-Changer Selection (Optional)	52

USB Operation (Optional)

Controlling USB (Optional)	52
----------------------------------	----

iPod® (Optional)

Playback	53
Searching for a desired Song	53
Searching by artist name	53
Direct Search Function	54
Selecting Playlist/Artist/Album/Genre/Composer/Podcast	54
Random Play Shuffle (M.I.X.)	54
Repeat Play	54

Information

About DVDs	55
Terminology	55
List of Language Codes	57
List of Country Codes	58
In Case of Difficulty	60
Specifications	63

Installation and Connections

Warning	64
Caution	64
Precautions	64
Installation	65
Connections	68
System Example	70

Operating Instructions

WARNING



WARNING

This symbol means important instructions. Failure to heed them can result in serious injury or death.

INSTALL THE PRODUCT CORRECTLY SO THAT THE DRIVER CANNOT WATCH TV/VIDEO UNLESS THE VEHICLE IS STOPPED AND THE EMERGENCY BRAKE IS APPLIED.

It is dangerous for the driver to watch TV/Video while driving a vehicle. Installing this product incorrectly enables the driver to watch TV/Video while driving. This may cause a distraction, preventing the driver from looking ahead, thus causing an accident. The driver or other people could be severely injured.

DO NOT WATCH VIDEO WHILE DRIVING.

Watching the video may distract the driver from looking ahead of the vehicle and cause an accident.

DO NOT OPERATE ANY FUNCTION THAT TAKES YOUR ATTENTION AWAY FROM SAFELY DRIVING YOUR VEHICLE.

Any function that requires your prolonged attention should only be performed after coming to a complete stop. Always stop the vehicle in a safe location before performing these functions. Failure to do so may result in an accident.

KEEP THE VOLUME AT A LEVEL WHERE YOU CAN STILL HEAR OUTSIDE NOISES WHILE DRIVING.

Excessive volume levels that obscure sounds such as emergency vehicle sirens or road warning signals (train crossings, etc.) can be dangerous and may result in an accident. LISTENING AT LOUD VOLUME LEVELS IN A CAR MAY ALSO CAUSE HEARING DAMAGE.

MINIMIZE DISPLAY VIEWING WHILE DRIVING.

Viewing the display may distract the driver from looking ahead of the vehicle and cause an accident.

DO NOT DISASSEMBLE OR ALTER.

Doing so may result in an accident, fire or electric shock.

USE ONLY IN CARS WITH A 12 VOLT NEGATIVE GROUND.

(Check with your dealer if you are not sure.) Failure to do so may result in fire, etc.

KEEP SMALL OBJECTS SUCH AS BOLTS OR SCREWS OUT OF THE REACH OF CHILDREN.

Swallowing them may result in serious injury. If swallowed, consult a physician immediately.

USE THE CORRECT AMPERE RATING WHEN REPLACING FUSES.

Failure to do so may result in fire or electric shock.

DO NOT BLOCK VENTS OR RADIATOR PANELS.

Doing so may cause heat to build up inside and may result in fire.

USE THIS PRODUCT FOR MOBILE 12V APPLICATIONS.

Use for other than its designed application may result in fire, electric shock or other injury.

DO NOT PLACE HANDS, FINGERS OR FOREIGN OBJECTS IN INSERTION SLOTS OR GAPS.

Doing so may result in personal injury or damage to the product.



CAUTION

This symbol means important instructions. Failure to heed them can result in injury or material property damage.

HALT USE IMMEDIATELY IF A PROBLEM APPEARS.

Failure to do so may cause personal injury or damage to the product. Return it to your authorized Alpine dealer or the nearest Alpine Service Centre for repairing.

KEEP FINGERS AWAY WHILE THE MOTORIZED FRONT PANEL OR MOVING MONITOR IS IN MOTION.

Failure to do so may result in personal injury or damage to the product.

PRECAUTIONS

Product Cleaning

Use a soft dry cloth for periodic cleaning of the product. For more severe stains, please dampen the cloth with water only. Anything else has the chance of dissolving the paint or damaging the plastic.

Temperature

Be sure the temperature inside the vehicle is between +45°C (+113°F) and 0°C (+32°F) before turning your unit on.

Moisture Condensation

You may notice the disc playback sound wavering due to condensation. If this happens, remove the disc from the player and wait about an hour for the moisture to evaporate.

Damaged Disc

Do not attempt to play cracked, warped, or damaged discs. Playing a bad disc could severely damage the playback mechanism.

Maintenance

If you have problems, do not attempt to repair the unit yourself. Return it to your Alpine dealer or the nearest Alpine Service Station for servicing.

Never Attempt the Following

Do not grip or pull out the disc while it is being pulled back into the player by the automatic reloading mechanism.

Do not attempt to insert a disc into the unit when the unit power is off.

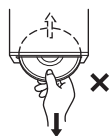

Inserting Discs

Your player accepts only one disc at a time for playback. Do not attempt to load more than one disc.

Make sure the label side is facing up when you insert the disc. "DISC ERROR" will be displayed on your player if you insert a disc incorrectly. If "DISC ERROR" continues to be displayed even though the disc has been inserted correctly, push the RESET switch with a pointed object such as a ballpoint pen.

Playing a disc while driving on a very bumpy road may result in skips, but this will not scratch the disc or damage the player.

Irregular Shaped Discs

Be sure to use round shaped discs only for this unit and never use any special shaped discs.

Use of special shaped discs may cause damage to the mechanism.



New Discs

To prevent the CD from jamming, "DISC ERROR" is displayed if discs with irregular surfaces are inserted or if discs are inserted incorrectly. When a new disc is ejected immediately after initial loading, use your finger to feel around the inside of the centre hole and outside edge of the disc. If you feel any small bumps or irregularities, this could inhibit proper loading of the disc. To remove the bumps, rub the inside edge of the hole and outside edge of the disc with a ballpoint pen or other such instrument, then insert the disc again.

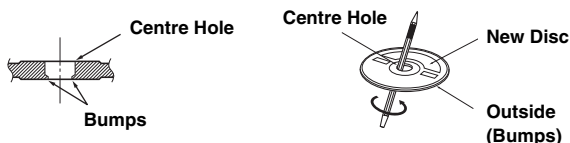

Installation Location

Make sure the IVA-W205R/IVA-W202R will not be installed in a location subjected to:

- Direct sun and heat
- High humidity and water
- Excessive dust
- Excessive vibrations

Correct Handling

Do not drop the disc while handling. Hold the disc so you will not leave fingerprints on the surface. Do not affix tape, paper, or gummed labels to the disc. Do not write on the disc.

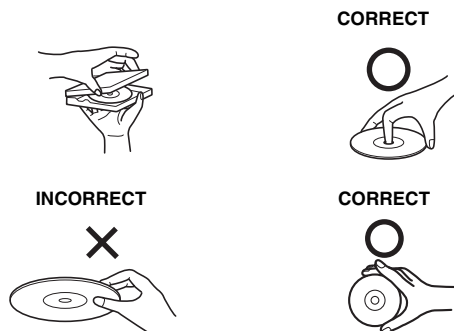

Disc Cleaning

Fingerprints, dust or soil on the surface of the disc could cause the DVD player to skip. For routine cleaning, wipe the playing surface with a clean, soft cloth from the centre of the disc to the outer edge. If the surface is heavily soiled, dampen a clean, soft cloth in a solution of mild neutral detergent before cleaning the disc.



Disc Accessories

There are various accessories available on the market for protecting the disc surface and improving sound quality. However, most of them will influence the thickness and/or diameter of the disc. Using such accessories can cause the disc to be out of standard specifications and may create operational problems. We recommend not using these accessories on discs played in Alpine DVD players.

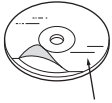

Transparent Sheet

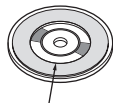

Disc Stabilizer

- After turning the system off, a slight ghost of the image will remain temporarily. This is an effect peculiar to LCD technology and is normal.
- In cold temperature conditions, the screen may lose contrast temporarily. After a short warm-up period, it will return to normal.

Alpine products equipped with the Ai-NET bus, connected to the IVA-W205R/IVA-W202R, can be operated from the IVA-W205R/IVA-W202R. Depending on the products connected, the functions and displays will vary. For details, consult your Alpine dealer.

Operation of some of the functions of this unit is very complex. Because of this, it was deemed necessary to place these functions into a special screen. This will restrict operation of these functions to times when the vehicle is parked. This ensures the focus of the driver's attention will be on the road and not on the IVA-W205R/IVA-W202R. This has been done for the safety of the driver and passengers.

Audio Processor Adjustments cannot be made if the car is moving. The car must be parked and the parking brake must be engaged for the procedure described in the Owner's Manual to be valid. The warning "CAN'T OPERATE WHILE DRIVING;" will be displayed if any attempts are made to perform these operations while driving.

The IVA-W205R/IVA-W202R draws minimal current even when its power switch is turned off. If the switched power (ignition) lead of the IVA-W205R/IVA-W202R is connected directly to the positive (+) post of the vehicle's battery, the battery may be discharged.

An SPST (Single-Pole, Single-Throw) switch (sold separately) can be added to simplify this procedure. Then, you can simply place it in the OFF position when you leave the vehicle. Turn the SPST switch back ON before using the IVA-W205R/IVA-W202R. For connecting the SPST switch, refer to the "Connection Diagram of SPST Switch (Sold Separately)" (page 67). If the power (ignition) lead is unswitched, it must be disconnected from the battery post should the vehicle be left unused for an extended period of time.

Discs Playable on This Unit

Playable Discs

The discs listed below can be played on this unit.

	Mark (logo)	Recorded Content	Disc size
DVD Video		Audio + Video	12 cm*
			8 cm
DVD Audio		Audio + Video	12 cm*
			8 cm
Video CD		Audio + Video	12 cm
			8 cm
Music CD		Audio	12 cm
			8 cm (CD single)

* Two-layer DVD disc compatible

Discs that cannot be played

DVD-ROMs, DVD-RAMs, CD-ROMs (excluding MP3/WMA files), photo CDs, etc.

DualDisc

This unit is not compatible with DualDisc.

Using a DualDisc may cause unit malfunction, and may cause disc damage when the disc is inserted/ejected.

DVD region number (playable region number)

This DVD player will play back any disc whose region number is 2 (or All). DVDs with a region number other than those listed below, cannot be played on this DVD player.



Video CDs

This DVD head unit is compatible with playback control (PBC) compatible Video CDs (version 2.0).

“PBC” is a function by which you can use menu screens recorded on the disc to find the scene you want to watch and view various types of information in dialog style.

Using compact discs (CD/CD-R/CD-RW)

If you use unspecified compact discs, correct performance cannot be guaranteed.

You can play CD-Rs (CD-Recordables)/CD-RWs (CD-ReWritables) which have been recorded only on audio devices. You can also play CD-Rs/CD-RWs containing MP3/WMA formatted audio files.

- Some of the following discs may not play on this unit:
Flawed discs, discs with fingerprints, discs exposed to extreme temperatures or sunlight (e.g., left in the car or this unit), discs recorded under unstable conditions, discs on which a recording failed or a re-recording was attempted, copy-protected CDs which do not conform to the audio CD industry standard.
- Use discs with MP3/WMA files written in a format compliant with this unit. For details, see pages 16 and 17.

To customers using CD-R/CD-RW

- If a CD-R/CD-RW cannot be played back, make sure the last recording session was closed (finalized).
- Finalize the CD-R/CD-RW if necessary, and attempt playback again.

Tips for making your own CDs

The IVA-W205R/IVA-W202R plays DVD Video, DVD Audio, Video CD, Audio CD and has a built in MP3/WMA decoder.

The following information is designed to help you create your own music CDs (either Audio CD or MP3/WMA encoded CD-R/RW files).

What is the difference between an Audio and MP3/WMA CD?

An Audio CD is the same format as the commercial CDs you buy in the store (also known as CD-DA). MP3 (MPEG-1 Audio Layer 3)/WMA (Windows Media Audio) is a data file that uses a compression scheme to reduce the size of the music file.*

Hybrid Audio CD and Data (MP3/WMA) CD-R/RW discs:

The IVA-W205R/IVA-W202R can read either sector on the disc. Choose CD-DA to play the CD audio section or MP3/WMA to play the MP3/WMA section.*

Multisession CD-R/RW:

Once a recording has been stopped, this is considered one session. If the disc is not closed (finalized), additional data may be added. Once this additional data has been recorded, this becomes a “multisession” CD. The IVA-W205R/IVA-W202R can only read multisession DATA Formatted discs (MP3/WMA files - Not Audio CD files).

Properly formatted MP3/WMA Discs:

Use ISO9660 formatting to insure proper playback. You may use standard ISO naming Level 1 (8.3 DOS standard), Level 2 (32 characters) or Joliet (Windows or Macintosh long filenames) file naming conventions.*

* Please consult the Owner’s manual for additional information.

On handling compact discs (CD/CD-R/CD-RW)

- Do not touch the surface.
- Do not expose the disc to direct sunlight.
- Do not affix stickers or labels.
- Clean the disc when it is dusty.
- Make sure that the disc is smooth and flat.
- Do not use commercially available disc accessories.

Do not leave the disc in the car or the unit for a long time.

Never expose the disc to direct sunlight.

Heat and humidity may damage the disc and you may not be able to play it again.

Using DVD-Rs/DVD-RWs/DVD+Rs/DVD+RWs

- This unit is compatible with discs recorded in the DVD-Video and DVD-VR mode.
- Note that discs not finalized (processed to enable to play on playback-only DVD players) cannot be played on this DVD player.
- Some discs may not play back, depending on the recording device and disc format.
- Discs or files utilizing copy protection, may not be playable. Some recording systems may not properly format copied files to enable proper playback.
- In the following cases, the disc may not play on this unit: discs recorded by certain DVD recorders, certain irregular discs, flawed discs, dirty discs, when the pickup lens of this DVD player is dirty, or when moisture condensation has occurred inside the unit.
- Be sure to follow all cautions included with your DVD-Rs/DVD-RWs/DVD+Rs/DVD+RWs discs.
- Do not put stickers, seals, or tape on the label side of DVD-Rs/DVD-RWs/DVD+Rs/DVD+RWs.
- Compared to the regular discs, DVD-Rs/DVD-RWs/DVD+Rs/DVD+RWs are more affected by heat, moisture, and direct sunlight. If left in a car, etc., damage may occur and it might not play on this unit.
- The operable temperature range for disc playback is as follows:
DVD-R/DVD-RW: -25 ~ +70°C
DVD+R/DVD+RW: +5 ~ +55°C

Disc terminology

Title

If titles are programmed for the DVD, these are the largest units of division of the information recorded on the disc.

Chapter

Each Title may also be divided into smaller divisions, called chapters. These can be specific scenes or musical selections.

- *This product incorporates copyright protection technology that is protected by U.S. patents and other intellectual property rights. Use of this copyright protection technology must be authorized by Macrovision, and is intended for home and other limited viewing uses only unless otherwise authorized by Macrovision. Reverse engineering or disassembly is prohibited.*
- *Manufactured under license from Dolby Laboratories. "Dolby," "Pro Logic" and the double-D symbol are trademarks of Dolby Laboratories.*
- *"DTS" is a registered trademark of DTS, Inc. and "DTS 2.0 + Digital Out" is a trademark of DTS, Inc.*
- *Windows Media and the Windows logo are trademarks, or registered trademarks of Microsoft Corporation in the United States and/or other countries.*
- *Apple, the Apple logo and iPod are trademarks of Apple Computer, Inc., registered in the U.S. and other countries.*
- *"MPEG Layer-3 audio coding technology licensed from Fraunhofer IIS and Thomson."*
- *"Supply of this product only conveys a license for private, non-commercial use and does not convey a license nor imply any right to use this product in any commercial (i.e. revenue-generation) real time broadcasting (terrestrial, satellite, cable and/or any other media), broadcasting/streaming via internet, intranets and/or other networks or in other electronic content distribution systems, such as pay-audio or audio-on-demand applications. An independent license for such use is required. For details, please visit <http://www.mp3licensing.com>"*

Getting Started

Accessory List

• Head unit	1
• Power cable.....	1
• Remote cable	1
• Mounting sleeve	1
• Bracket key.....	2
• Flush Head Screw (M5 × 8).....	6
• Screw (M5 × 8)	8
• Rubber Cap	1
• Hex Bolt	1
• Face plate (7mm / 20mm)	2
• Mounting Position Seal	2
• Slot Securing Screw (M2 × 4) (IVA-W205R only)*	2
• Owner's Manual.....	1 set

* To customers who do not use an optional portable navigation:
If necessary, secure the slot panel with this screw.

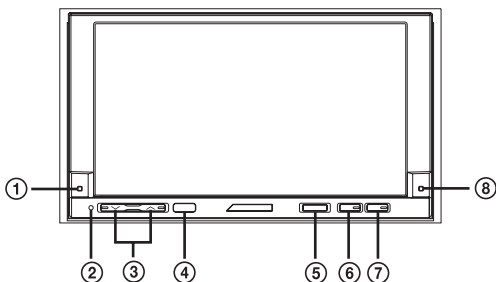

Connectable to Remote Control Interface Box

You can operate this unit from the vehicle's control unit when an Alpine Remote Control Interface Box (optional) is connected. For details, contact your Alpine dealer.

Location of Controls

- 1 IVA-W205R: DOCK indicator**
Lights when a portable navigation device is inserted into the unit.
IVA-W202R: DISC indicator
Lights when a disc is inserted into the unit.
- 2 RESET switch**
Be sure to press the RESET switch when using the unit for the first time, after installing the CD changer, after changing the car battery, etc.
Turn off the unit power, press RESET with a ballpoint pen or similar pointed object.
- 3 √/∧ button**
Press to adjust the volume.
- 4 Remote Sensor**
Point the optional remote control transmitter towards the remote sensor within a range of 2 meters.
- 5 SOURCE/⏻ button**
Turns the power on. Press and hold for at least 2 seconds to turn the power off.
Recalls the SOURCE selection screen.

- 6 TA/AUDIO button**
Turns the T. INFO mode ON or OFF.
Press and hold for at least 2 seconds to recall the AUDIO SETUP screen. Press and hold for at least 2 seconds to cancel the T. INFO mode when the T. INFO mode is turned on.
- 7 ▲ button**
IVA-W205R: Displays the EJECT/TILT screen.
IVA-W202R: Ejects a disc.
- 8 POWER indicator**
Blinks when an operation is performed. However, turns off when Beep is set to OFF.

About the button descriptions used in this Owner's Manual

- The buttons found on the face of the unit are expressed in bold (e.g. **SOURCE/⏻**). The buttons found on the touch-screen display are shown in bold within brackets, [] (e.g. [**SOURCE**]).
- This Owner's Manual explains mainly the function of soft buttons, when a soft button and a unit button have the same function.

Turning Power On or Off

Some of this unit's functions cannot be performed while the vehicle is in motion. Be sure to stop your vehicle in a safe location and apply the parking brake, before attempting these operations.

1 Press **SOURCE/⏻** to turn on the unit.

- The unit can be turned on by pressing any button. However, the IVA-W202R cannot be turned on even if ▲ (eject) is pressed.

2 Press and hold **SOURCE/⏻** for at least 2 seconds to turn off the unit.

- The IVA-W205R/IVA-W202R is a precision device. With gentle handling, its unique capabilities can be enjoyed for a long time.
- In low ambient temperature conditions, the display may be dim for a short period of time immediately after the power is turned on. Once the LCD has warmed up, the display returns to normal.

Inserting/Ejecting a Disc

IVA-W205R:

- 1 Press \blacktriangle on the unit.**
The display changes to the EJECT/TILT screen.
- 2 Insert a disc:**
Touch [OPEN] on the EJECT/TILT screen.
The movable monitor will open, then insert a disc into the disc slot. Inserting a disc will close the monitor automatically.

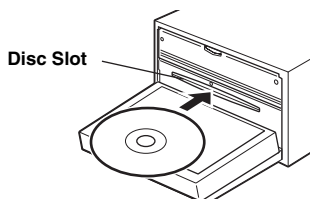

Eject the disc:

Touch [\blacktriangle] of DISC on the EJECT/TILT screen.
The movable monitor will open. Then the disc is ejected.

- 3 Touch [CLOSE] on the EJECT/TILT screen.**
The movable monitor will close.

IVA-W202R:

Insert the disc:

Press \blacktriangle .
The movable monitor will open.
Insert disc in to Disc slot part.

Eject the disc:

Press \blacktriangle again.
Disc is ejected.

- Touching [CONTROL] or [RETURN] return to the earlier main source screen (IVA-W205R only).
- Do not apply shock to the movable monitor when it is open as it may result in malfunction of the unit.
- The monitor may be dim during low temperature and immediately after turning on the power. The brightness will return to normal as time elapses.
- The monitor will stop at the set tilt angle when closing.

CAUTION

Keep hands (or any other object) away from the monitor while it is opening or closing to avoid damage or injury. The back of the movable monitor will get very warm under normal operating conditions. This is not a malfunction. Do not touch.

Adjusting the Monitor Viewing Angle

Adjust the monitor's angle for better visibility.

IVA-W205R:

- 1 Press \blacktriangle on the unit.**
The display changes to the EJECT/TILT screen.
- 2 Touch [\blacktriangle] or [\blacktriangledown] of TILT to adjust the desired monitor angle.**
The monitor angle can be adjusted in 5 stages.
- 3 Touch [RETURN] to return to the previous screen.**

IVA-W202R:

- 1 Touch [SETUP] for the selected source on the main screen.**
The setup selection screen is displayed.
- 2 Touch [DISPLAY].**
- 3 Touch [\blacktriangledown] or [\blacktriangle] of TILT to adjust the desired monitor angle.**
Pressing the buttons changes the screen angle by 5 stages.
- 4 Touch [RETURN] to return to the previous screen.**

- This function is adjustable while driving.
- If the monitor touches an obstacle while the angle is being adjusted, it will stop immediately.
- The screen colour will vary when viewed at certain angles. Adjust the screen angle for the best viewing position.
- If the voltage of the vehicle's battery power is low, the screen may blink when the screen angle is changed. This is normal and not a malfunction.
- Touching and holding [RETURN] for at least 2 seconds will change to the main source screen.

Adjusting the Volume

Adjust the volume by pressing \blacktriangledown or \blacktriangle .

Volume decreases/increases continuously by pressing and holding \blacktriangledown or \blacktriangle .

Volume: 0 - 35

- The MUTE function can be performed by using the optional remote control.

How to view the Display

Touchscreen operation

The display unit is equipped with tactile feedback (PULSETOUCH).

What is the tactile feedback (PULSETOUCH)?

When you touch a button graphic in the display, you will feel a mild vibration and click on the display panel surface. This feedback enables you to easily identify action areas in the display.

- Be sure to touch the button lightly with the pad of your finger on the display to protect the display.
- If you touch a button and there is no reaction, remove your finger from the display, and try again.

About the button descriptions used in this Owner's Manual

- Soft buttons, ones found in the display, are shown in bold enclosed in brackets, [] (e.g. [SOURCE]).
- Whenever a soft button and a head unit button have the same function, the explanations in this Owner's Manual will describe the function of the soft button.

Recalling the Source

Here is an example explanation for the Radio mode display on how to recall a source.

1 Touch [SOURCE] on the main screen.

The SOURCE selection screen is displayed.

Display example for SOURCE selection screen



- ① Changes to main source screen.
 - ② Displays source modes that can be selected. (The kind of source modes that are displayed varies depending on connection and setting.)
 - ③ Changes to the Rear selection screen when "Setting the Picture Output" (page 36) is set to ON.
 - ④ Returns to the previous screen.
- When the source icon is not displayed on SOURCE selection screen, it is displayed on the next page.
Touching [▼] on the SOURCE selection screen will display the next page; touching [▲] will return to the previous page.

2 Touch [RADIO].

The screen changes to the Radio mode main display.

Display example for Radio (MW) main screen

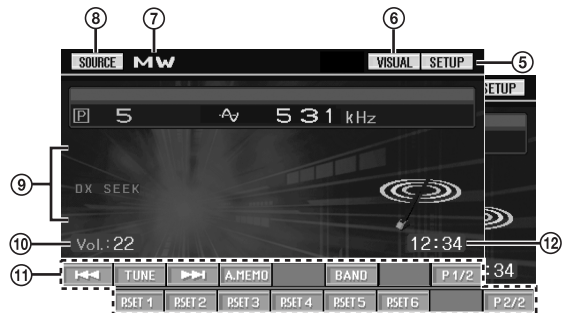

- ⑤ Changes to SETUP selection screen.
- ⑥ Changes to VISUAL selection screen.
- ⑦ Displays the source name, such as radio band, etc., that is selected.
- ⑧ Changes to the SOURCE selection screen (to Step 1 screen).
- ⑨ Working state indicator.
- ⑩ Displays volume level.
- ⑪ Function Guide:
The function guide display varies depending on each source.
The contents of the function guide change by touching [P1/2]* or [P2/2]* on the function guide, and many other operations can be performed.
- ⑫ Displays time.

* Display may vary depending on the connected devices.

3 Touch [SOURCE] on the main source screen to change to another source screen, and select the desired source from the SOURCE selection screen.

- The screen can be changed to the VISUAL selection screen by touching [VISUAL].
Set to VISUAL in "Setting the VISUAL Soft Button" (page 37).
- The screen can be changed to the SETUP selection screen by touching [SETUP].
- After 5 seconds of each operation in the visual mode, the screen changes to the visual screen only.
To display the main source screen, touch the display panel, then touch [CONTROL] on the screen. The SOURCE selection screen appears by touching [SOURCE] on the changed main source screen.

Displaying the Numeric Keypad Input Screen

The numeric keypad input screen is displayed when the DVD mode is selected for searching a title or chapter, and also for entering a country code or password for the DVD setup item.

- 1 Touch **[10KEY]** on the main source screen.
- 2 Touch the desired numeric key.

Display example for numeric keypad

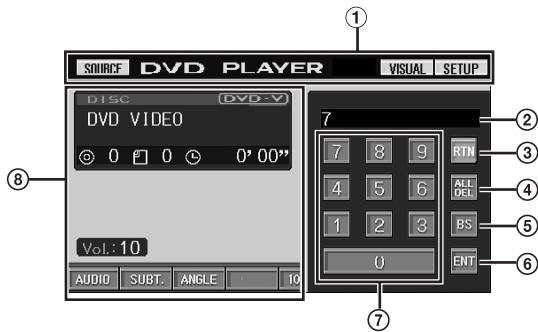

- ① Operation buttons of this area can be used while displaying the numeric keypad input screen.
- ② Input screen area.
- ③ Closes numeric keypad input screen.
- ④ All input numbers will be deleted.
- ⑤ Previous number will be deleted.
- ⑥ Input number is confirmed.
- ⑦ Numeric keypad.
- ⑧ The numeric keypad input screen closes when the area is touched while displayed.

- 3 Touch **[ENT]** to confirm your entry.

Radio

Display example for Radio (MW) main screen

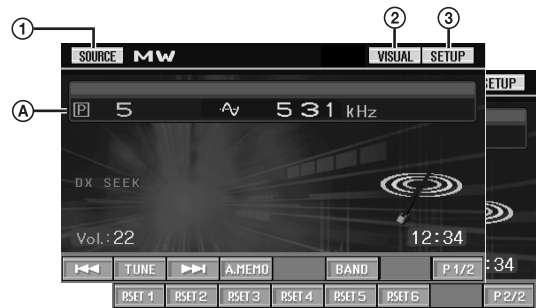

- ① **[SOURCE]** button: Refer to page 11.
- ② **[VISUAL]** button: Displays the VISUAL selection screen.
- ③ **[SETUP]** button: Displays the SETUP selection screen.
- Ⓐ Displays the preset number/frequency.

Listening to the Radio

- 1 Touch **[SOURCE]** on the main source screen.
The SOURCE selection screen is displayed.
- 2 Touch **[RADIO]**.
The radio mode is activated and the display changes to the Radio Mode screen.
- 3 Touch **[BAND]** to select the desired radio band.
Each press changes the bands as follows:
FM-1 → FM-2 → FM-3 → MW → LW → FM-1
- 4 Touch **[TUNE]** to choose the tuning mode.
Each touch changes the tuning mode display.
Distance → Local → Manual → Distance
 - There are two modes you can select for auto tuning, DX and Local:
 - DX (Distance) mode (with DX SEEK indicator ON);
Both strong and weak stations will be tuned in.
 - Local mode (with SEEK indicator ON);
Only strong stations will be tuned in.
The initial setting is DX.
- 5 Touch **[<<<]**, **[>>>]** or **[<<]**, **[>>]** to change the radio frequency up or down respectively.
In manual mode, touch and hold to change the frequency continuously.

- You can search for a station by PTY (Programme Type) Tuning in the FM radio mode. For operation, refer to "PTY (Programme Type) Tuning" (page 14).

Presetting Stations Manually

- 1 **Tune in a desired radio station you wish to store in the preset memory by manual or automatic seek tuning.**
- 2 **Touch [P1/2] to change the function guide.**
- 3 **Touch and hold any one of the preset buttons [P.SET 1] through [P.SET 6] for at least 2 seconds.**
The selected station is stored.
- 4 **Repeat the procedure to store up to 5 other stations onto the same band.**
To use this procedure for other bands, simply select the desired band and repeat the procedure.

A total of 30 stations can be stored in the preset memory (6 stations for each band; FM1, FM2, FM3, MW or LW).

- *If a preset memory has already been set in the same preset number; it will be cleared and the new station will be memorised.*

Presetting Stations Automatically

The tuner can automatically seek and store 6 strong stations in the selected band in order of signal strength.

After selecting the desired band, touch [A.MEMO].

The tuner automatically seeks and stores 6 strong stations into [P.SET 1] to [P.SET 6] in order of signal strength.

When the automatic storing has been completed, the tuner goes to the station stored in [P.SET 1].

- *If no stations are stored, the tuner will return to the original station you were listening to before the automatic storing procedure began.*

Tuning to Preset Stations

You can tune in the preset stations in memory on each band using the preset number.

- 1 **After selecting the desired band, touch [P1/2] to change the function guide.**
- 2 **Touch any one of the preset buttons [P.SET 1] through [P.SET 6] that has a station stored to it.**
The preset station is received.

RDS Operation

Turning AF (Alternative Frequencies) On or Off

The RDS (Radio Data System) is a radio information system using the 57 kHz subcarrier of regular FM broadcast. The RDS allows you to receive a variety of information such as traffic information, station names, and to automatically re-tune to a stronger transmitter that is broadcasting the same programme.

- 1 **Touch [SETUP] on the main source screen.**
The SETUP selection screen is displayed.
- 2 **Touch [SOURCE].**
The source setup screen appears.
- 3 **Touch [>>>] of RDS.**
The display changes to the RDS mode screen.
- 4 **Touch [AF] to select the AF (Alternative Frequency) ON or OFF mode.**
 - *When the AF ON mode is selected, the unit automatically tunes to a strong signal station in the AF list.*
 - *Use the AF OFF mode when automatic re-tuning is not required.*
- 5 **Touch [RETURN] to return to the previous screen.**

Tips

- *If the unit receives the PTY31 (Emergency Broadcast) signal, the unit will show "ALARM" in the display only when PTY31 is set to on. For operation, refer to "Setting PTY31 (Emergency Broadcast) Reception" (page 33).*
- *The RDS digital data includes the following:*

PI	Programme Identification
PS	Programme Service Name
AF	List of Alternative Frequencies
TP	Traffic Programme
TA	Traffic Announcement
PTY	Programme Type
EON	Enhanced Other Networks
- *Refer to page 33 about "PI SEEK Setting", "Receiving RDS Regional (Local) Stations", "Switching the Display Language of PTY (Programme Type)" and "Setting PTY31 (Emergency Broadcast) Reception".*

Receiving Traffic Information

Press **TA/AUDIO** to turn on the **Traffic Information mode**.

When the traffic information station is tuned in, the TA indicator lights up.

Traffic information is heard only when it is being broadcast. If traffic information is not being broadcast, the unit is set in the standby mode.

When a traffic information broadcast begins, the unit automatically receives it and the display shows "T. INFO."

When traffic information broadcast is over, the unit will automatically set in the standby mode.

- *If the traffic information broadcast signal falls below a certain level, the unit remains in the receiving mode for 1 minute. If the signal remains below a certain level for over 70 seconds, "TA" blink light up in the display.*
- *If you do not want to listen to the traffic information being received, press **TA/AUDIO** to skip that traffic information message. The T. INFO mode will remain in the ON position to receive the next traffic information message.*
- *If the volume level is changed while receiving traffic information, the changed volume level will be memorised. When traffic information is received next time, the volume level will be automatically adjusted to the level memorised.*

PTY (Programme Type) Tuning

1 In the **FM Radio mode**, touch **[PTY]** on the **RDS mode screen**.

The PTY mode is activated.

The Programme Type of the station being currently received will be displayed.

2 Touch **[◀]** or **[▶]** after activating the PTY mode to choose the desired programme type while "PTY" (programme type) is displayed.

Each press scrolls the programme type by one.

3 Touch **[PTY]** after selecting the programme type to start searching for a station of the selected programme type.

If no station is found, "No PTY" will be displayed.

Receiving Traffic Information While Playing CD or Radio

The example explained here is how to receive the traffic information broadcast during CD playback.

1 In the **CD mode**, press **TA/AUDIO** to turn on the **Traffic information mode**.

The unit automatically starts to search the receivable traffic broadcasts.

When the traffic information broadcast is searched out, the CD mode is switched to the Radio mode and the unit receives the traffic information broadcast.

- When the traffic information broadcast starts, the unit automatically mutes the CD.
- When the traffic information broadcast finishes, the unit automatically returns to the original source you were playing before the traffic information broadcast began.
- *The receiver is equipped with the EON (Enhanced Other Networks) function so if the station being received does not broadcast the traffic information, the receiver automatically tunes in the related station that broadcasts the traffic information.*

2 When the traffic information broadcast has finished, the unit returns to the CD mode.

Priority News

This function allows you to preset to give priority to the News programme. You will never miss the News programme as the unit automatically gives priority to the News programme whenever it begins broadcasting, and interrupts the programme you are currently listening. This feature is functional when your unit is set to a mode other than the LW and MW modes.

1 Touch **[NEWS]** to activate the **PRIORITY NEWS mode**.

The "NEWS" indicator appears in the display. Touch **[NEWS]** again to deactivate the Priority News mode and return to the programme you were previously listening.

2 Touch **[RETURN]** to return to the previous screen.

Displaying Radio Text

Text messages from a radio station can be displayed.

1 Tune in a radio station that transmits text messages.

2 Touch **[INFO.]** in the **FM radio mode** to activate the **Radio Text mode**.

The display shows "WAIT" for a few seconds.

3 To deactivate the **Radio Text mode**, touch **[INFO.]**.

- *If there is no receivable text message or the unit cannot receive a text message properly, the display shows "NO TEXT".*

CD/MP3/WMA

Display example for MP3/WMA main screen

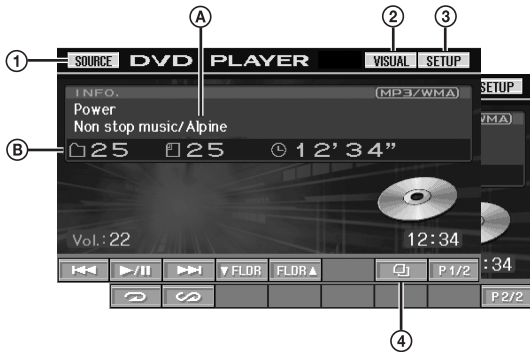

- ① [SOURCE] button: Refer to page 11.
- ② [VISUAL] button: Displays the VISUAL selection screen.
- ③ [SETUP] button: Displays the SETUP selection screen.
- ④ [] button: Refer to page 27.
- Ⓐ CD:

Displays the Track text^{*1}/Disc text^{*1}/Artist.

- If there is neither Track nor Disc name information, "NO TEXT" will be displayed.

MP3/WMA:

After displaying the file name in the upper line, the track name is displayed if there is ID3 tag information. After displaying the folder name in the lower line, the album name/artist name are displayed if there is ID3 tag information.

- Ⓑ CD: Displays the disc number^{*2}/track number/elapsed time.

MP3/WMA:

Displays the disc number^{*3}/folder number/file number/elapsed playback time.

^{*1} Displayed when a CD text disc is inserted.

^{*2} Displayed when a CD changer is connected.

^{*3} Displayed when an MP3 compatible CD changer is connected.

Playback

- 1 Touch [SOURCE] on the main source screen. The SOURCE selection screen is displayed.

- 2 Touch [DVD PLAYER]. The display shows the DVD player mode screen.

When a CD/MP3/WMA is inserted into the DISC SLOT of the IVA-W205R/IVA-W202R, with the label side facing up, the unit starts to play the CD/MP3/WMA.

- 3 Touch [◀◀] or [▶▶] to select the desired track (file).

Returning to the beginning of the current track (file):
Touch [◀◀].

Fast reverse:
Touch and hold [◀◀].

Advancing to the beginning of the next track (file):
Touch [▶▶].

Fast forward:
Touch and hold [▶▶].

To pause playback

Touch [▶/||].
Touching [▶/||] again will resume playback.

To eject the disc

IVA-W205R: Refer to "Inserting/Ejecting a Disc" (page 10).
IVA-W202R: Press ▲.

- The IVA-W205R/IVA-W202R model includes a built-in MP3/WMA unit. You can play CD-ROMs, CD-Rs, and CD-RWs containing MP3/WMA files on this unit. Use the format compliant with this unit. For further information about playing or storing MP3/WMA files, refer to pages 16 and 17 before using the unit.
- A WMA format file that is protected by DRM (Digital Rights Management) cannot be played back on this unit.
- The unit can play discs containing both audio data and MP3/WMA data.
- The MP3/WMA indicator is lit during MP3/WMA playback.
- The track display for CD audio data playback is the track numbers recorded on the disc.
- Three-inch (8 cm) CDs can be used.
- "Playing MP3/WMA Data (File Play Mode)" is mentioned on page 33.
- If an MP3/WMA disc with many files and folders is played, it takes a little longer than normal to start playback.
- Touch [] to activate the search mode. For operations, refer to "Search Function" on page 27. However, the search mode function does not work in the CD changer mode.
- The playback time may not be correctly displayed when a VBR (Variable Bit Rate) recorded file is played back.

Repeat Play

Touch [↺] to play back repeatedly the track currently being played.

The track (file) will be played repeatedly.

Touch [↺] again and select OFF to deactivate Repeat play.

CD: RPT → RPT DISC*¹ → (off) → RPT

MP3/WMA:

- 1 Touch [P1/2]*³ to change the function guide.
- 2 Touch [↺] and select the desired Repeat play.

RPT → RPT FLDR*² → RPT DISC*¹ → (off) → RPT

**¹ If a CD Changer or an MP3 compatible CD changer is connected and the RPT DISC mode is selected, the unit repeatedly plays back all tracks (files) on the disc selected.*

**² Only files in a folder are repeatedly played back.*

**³ Display may vary depending on the connected devices.*

M.I.X. (Random Play)

Touch [∞] during playback.

The tracks (files) on the disc will be played back in a random sequence.

To cancel M.I.X. play, touch [∞].

CD: M.I.X. → M.I.X. ALL*¹ → (off) → M.I.X.

MP3/WMA:

- 1 Touch [P1/2]*⁴ to change the function guide.
- 2 Touch [∞] and select the desired M.I.X. play.

M.I.X. FLDR*³ → M.I.X.*² → (off) → M.I.X. FLDR*³

**¹ If a CD Changer equipped with the M.I.X. ALL function is connected, M.I.X. ALL will also be selectable.*

In this mode, the tracks on all the CDs in the current magazine will be included in the random playback sequence.

**² If an MP3 compatible CD changer is connected, all files in a disc are played back in random sequence, and playback shifts to the next disc.*

**³ Only files in a folder are played back in random sequence in the M.I.X. FLDR mode.*

**⁴ Display may vary depending on the connected devices.*

Selecting Folders (concerning MP3/WMA)

Touch [▼ FLDR] or [FLDR ▲] to select the folder.

About MP3/WMA

CAUTION

Except for private use, duplicating audio data (including MP3/WMA data) or distributing, transferring, or copying it, whether for free or for a fee, without permission of the copyright holder is strictly prohibited by the Copyright Act and by international treaty.

What is MP3?

MP3, whose official name is "MPEG-1, 2, 2.5 Audio Layer 3," is a compression standard prescribed by the ISO, the International Standardization Organization and MPEG which is a joint activity institution of the IEC.

MP3 files contain compressed audio data. MP3 encoding is capable of compressing audio data at extremely high ratios, reducing the size of music files to as much as one-tenth their original size. This is achieved while still maintaining near CD quality. The MP3 format realizes such high compression ratios by eliminating the sounds that are either inaudible to the human ear or masked by other sounds.

What is WMA?

WMA, or "Windows media™ Audio," is compressed audio data. WMA is similar to MP3 audio data and can achieve CD quality sound with small file sizes.

Method for creating MP3/WMA files

Audio data is compressed by using MP3/WMA specified software. For details on creating MP3/WMA files, refer to the user's manual for that software.

MP3/WMA files that can be played back by this device have the file extension "mp3" / "wma". Files with no extension cannot be played back. (WMA ver. 9 is supported.)

Supported playback sampling rates and bit rates

MP3

Sampling rates: 32 kHz ~ 48 kHz

Bit rates: 32 - 320 kbps

WMA

Sampling rates: 32 kHz ~ 48 kHz

Bit rates: 32 - 320 kbps

This device may not play back correctly depending on sampling rates or bit rates.

ID3 tags/WMA tags

If tag data is in an MP3/WMA file, this device can display the title (track title), artist name, and album name ID3 tag/WMA tag data (maximum 128 characters).

This device can only display single-byte alphanumeric characters and the underscore. For non-supported characters, "NO SUPPORT" is displayed.

The number of characters may be limited, or not correctly displayed, depending on the tag information.

Producing MP3/WMA discs

MP3/WMA files are prepared, then written to a CD-R or CD-RW (DVD-R/DVD-RW) using CD-R writing software. A disc can hold up to 1,024 files/256 folders (including Root Folders). Depending on the structure of the folders or files, it may take time to read a disc. In this case, it is recommended to decrease the number of folders or files.

Media supported

The media that this device can play back are CD-ROMs, CD-Rs, CD-RWs, DVD-Rs and DVD-RWs.

Corresponding File Systems

This device supports discs formatted with ISO9660 Level 1 or Level 2.

Under the ISO9660 standard, there are some restrictions to remember.

The maximum nested folder depth is 8 (including the root directory). The number of characters for a folder/file name is limited.

Valid characters for folder/file names are letters A-Z (all caps), numbers 0-9, and '_' (underscore).

This device also can play back discs in Joliet, etc., and other standards that conform to ISO9660. However, sometimes the file names, folder names, etc., are not displayed correctly.

Formats supported

This device supports CD-ROM, CD-ROM XA, Mixed Mode CD, Enhanced CD (CD-Extra) and Multi-Session.

This device cannot correctly play back discs recorded with Track At Once or packet writing.

Order of files

Files are played back in the order that the writing software writes them to the disc. Therefore, the playback order may not be what's expected. Verify the writing order in the software's documentation. The playback order of the folders and files is as follows.

(The following numbers may differ from actually displayed numbers.)

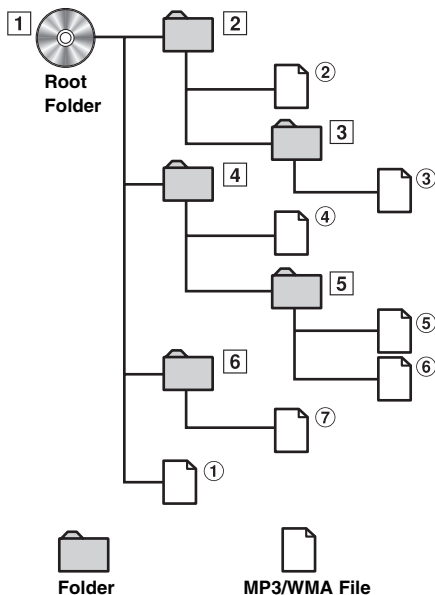

Terminology

Bit rate

This is the "sound" compression rate specified for encoding. The higher the bit rate, the higher the sound quality, but also the larger the files.

Sampling rate

This value shows how many times per second the data is sampled (recorded). For example, music CDs use a sampling rate of 44.1 kHz, so the sound is sampled (recorded) 44,100 times per second. The higher the sampling rate, the higher the sound quality, but also the larger the volume of data.

Encoding

Converting music CDs, WAVE (AIFF) files, and other sound files into the specified audio compression format.

Tag

Song information such as track titles, artist names, album names, etc., written into MP3/WMA files.

MP3: ID3 tag

WMA: WMA tag

Root folder

The root folder (or root directory) is found at the top of the file system. The root folder contains all folders and files. It is created automatically for all burned discs.

DVD/Video CD

Display example for DVD Video main screen



- ① [SOURCE] button: Refer to page 11.
 - ② [VISUAL] button: Displays the VISUAL selection screen.
 - ③ [SETUP] button: Displays the SETUP selection screen.
 - Ⓐ Displays the disc (DVD VIDEO, DVD AUDIO, PROGRAM/PLAYLIST (DVD-VR), VIDEO CD) being played back.
 - Ⓑ Displays the title number/chapter number/elapsed playback time for a DVD Video.
Displays the group number/track number/elapsed playback time for a DVD Audio.
Displays the programme or playlist number/chapter number/elapsed playback time for a DVD-VR.
Displays the track number/elapsed playback time for a Video CD (When PBC is turned off).
- Some operations cannot be carried out depending on the disc or playback screen.
 - Displays of the function guide [P1/2], etc., may vary depending on the connected device(s).

Disc types that can be used for each heading are represented by the following marks.

- DVD-V** DVD Commercial Video discs (used for the distribution of movies, etc.) or a DVD-R/DVD-RW, DVD+R/DVD+RW recorded in a video mode can be used.
(Including a disc recorded with both DVD video and DVD audio data, played back when "VIDEO" is set in "Setting of the DVD-Audio Playback Mode" on page 32.)
- DVD-A** DVD Commercial Audio discs can be used.
- DVD-VR** DVD-R/DVD-RW discs recorded in DVD-VR mode can be used.
- VCD** Video CD discs can be used.

Playing a Disc **DVD-V** **DVD-A** **DVD-VR** **VCD**

IVA-W205R/IVA-W202R has a built-in DVD player. When an optional Alpine DVD/Video CD/CD player (or DVD changer) is connected to the IVA-W205R/IVA-W202R, you can control it from the IVA-W205R/IVA-W202R. (except some operations)

⚠ WARNING

It is dangerous for the driver to watch the TV/DVD/Video while driving the vehicle. The driver may be distracted from looking ahead and an accident could occur.

Install the IVA-W205R/IVA-W202R correctly so that the driver cannot watch TV/DVD/Video unless the vehicle is stopped and the emergency brake is applied.

If the IVA-W205R/IVA-W202R is not installed correctly, the driver will be able to watch the TV/DVD/Video while driving the vehicle and may be distracted from looking ahead causing an accident. The driver or other people could be severely injured.

To display the DVD mode screen



- If you try to activate the auxiliary device while driving, the display will show the warning-PICTURE OFF FOR YOUR SAFETY.

⚠ Caution

- Not all functions will operate for every DVD. See the individual DVD's instructions for details on the features supported.
- Fingerprints on a disc may adversely affect playback. If a problem occurs, remove the disc and check for fingerprints on the playback side. Clean the disc if necessary.
- If you switch the power or Ignition key OFF or change sources during playback, playback will continue where you left off when you resume playback.
- If you try to perform an invalid operation (based on the type of disc being played), the following mark is displayed on the monitor screen: ⊘

- **Play Position Memory Function**
Even if you turn power off or switch the Ignition key to OFF during playback or change the source, playback will continue from the point where playback stopped when the power is turned ON again.

1 Touch [SOURCE] on the main source screen.

The SOURCE selection screen is displayed.

2 Touch [DVD PLAYER].

The display shows the DVD player mode screen. Insert a disc with the label side facing up. The unit starts to play the disc.

When an optional Alpine DVD player is connected:
Insert a disc into the DVD/Video CD/CD player, the player starts playing.

- The operation screen changes to the visual screen in the DVD or Video CD mode for 5 seconds after an operation has been performed. Touch the display panel to display the operation screen again.
- The display mode can be changed by touching [WIDE].
For operation, see "Switching Display Modes" on page 28.

To eject the disc

IVA-W205R: Refer to "Inserting/Ejecting a Disc" (page 10).

IVA-W202R: Press ▲.

- The reverse side of a double-sided DVD will not be played automatically.
Remove the disc, turn it over, and reinsert it.
- DO NOT insert discs containing maps for the navigation system. Doing so could result in damage.
- Refer also to "DVD Setup" (pages 29 to 33).
- Be sure the remote input lead is connected to the remote output lead of this unit when a DVD changer or DVD player is connected. If not correctly connected, touch operation cannot be performed.
- To return to the previous screen during Video CD playback (when PBC is set to ON), touch [RETURN] after touching [PI/2] of the function guide. However, the function may vary depending on the disc.
- "CAN'T DOWNMIX" is displayed when a Downmix (multi-channel signals are mixed into 2 ch) prohibited section of a DVD-Audio disc is played. In this case, only the Lch/Rch recorded on the disc is output as sound. (The sound of Centre speaker, L-surround speaker, R-surround speaker and Subwoofer is not output.)

If a menu screen appears

On DVDs and Video CDs with playback control (PBC), menu screens may appear automatically. If this happens, perform the operation described below to start playback.

- To play back a DVD-Audio disc, set "VCAP" in "Setting of the DVD-Audio Playback Mode" (page 32).

Direct Menu Operations DVD-V DVD-A

- 1 Touch the DVD menu directly.
 - Some operations cannot be performed depending on the disc.

Menu Operations DVD-V DVD-A



- 1 Touch [KEY].
The menu operation mode will be displayed.

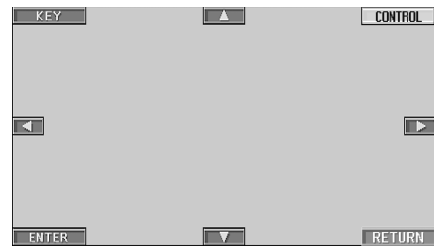

Touch [RETURN] to return to the previous display.

- 2 Select a desired menu item by touching [▲], [▼], [◀] or [▶].

- 3 Touch [ENTER] to confirm the selected item.

Numeric Keypad Input Operations DVD-V DVD-A

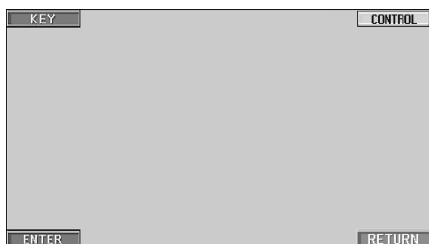

- 1 Touch [KEY].
The menu operation mode appears.
- 2 Touch [KEY] again.
The numeric keypad input mode screen appears.

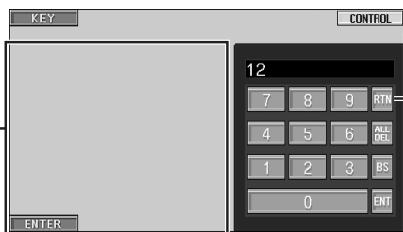

The numeric keypad input screen closes when the area is touched while displayed.

Touch [RTN] to close the numeric keypad input screen.

- 3 Touch a desired number.
- 4 Touch [ENT] on the numeric keypad mode screen to confirm your selection.

Numeric Keypad Input Operations VCD

When PBC is turned OFF, the menu screen is not displayed. Turn it ON to display the screen. (See "Setting the Video CD Play Mode" on page 33.)

- 1 Touch [P1/2] in the Video CD mode to change the function guide.
- 2 Touch [10KEY].
The numeric keypad is displayed.
- 3 Touch and input a desired number.
- 4 Touch [ENT] to confirm.

Displaying the Top Menu Screen

DVD-V DVD-A

When a DVD contains two or more titles, the top menu screen appears.

Touch [TOP MENU] on the DVD mode main screen.

The top menu screen appears.

- To perform necessary operations, see "If a menu screen appears" on page 19.
- To play back a DVD-Audio disc, set "VCAP" in "Setting of the DVD-Audio Playback Mode" (page 32).

Displaying the Menu Screen DVD-V

With a DVD having two or more menus, a menu screen will appear for the programmes available, in addition to the main programmes.

Touch [MENU] on the DVD mode main screen.

The menu screen appears.

- To perform necessary operations, see "If a menu screen appears" on page 19.

Displaying the Menu Operation Mode Screen DVD-V DVD-A

1 Touch [P1/2]* on the DVD mode main screen.

The function guide changes.

* Touch [P1/3] while playing a DVD-Audio disc.

2 Touch [MENU CONT].

The menu operation mode screen appears.

- For further operation, see "If a menu screen appears" on page 19.
- To play back a DVD-Audio disc, set "VCAP" in "Setting of the DVD-Audio Playback Mode" (page 32).

Searching by Programme DVD-VR

1 Touch [TOP MENU] on the DVD mode main screen while playing a DVD-VR disc.

The programme search list screen is displayed.

2 Touch [▶] of the programme you want to play.

The selected programme is played back, and then returns to the DVD mode main screen.

Searching by Playlist DVD-VR

1 Touch [MENU] on the DVD mode main screen while playing DVD-VR disc.

The playlist search list screen is displayed.

2 Touch [▶] of the playlist you want to play.

The selected playlist is played back, and then returns to the DVD mode main screen.

- Only discs containing a Playlist can be operated.

Stopping Playback (PRE STOP)

DVD-V DVD-A DVD-VR VCD

Press the stop button during playback to stop playback. That position is stored in the memory.

1 Touch [■] once during playback.
"PRE STOP" is displayed.

2 Touch [▶ / ||] in the PRE STOP mode.
Playback starts from the position at which it was stopped.

- For some discs, the position at which playback was stopped may not be accurate.
- To play back a DVD-Audio disc, set "VCAP" in "Setting of the DVD-Audio Playback Mode" (page 32).

Stopping Playback

DVD-V DVD-A DVD-VR VCD

Touch [■] twice or touch and hold [■] for at least 2 seconds during playback.
"STOP" is displayed, and playback stops.

- Playback starts from the beginning when [▶ / ||] is touched while playback is stopped.

Fast-forward/Fast-reverse

DVD-V DVD-A DVD-VR VCD

DVD-Video, DVD-VR, Video-CD, DVD-Audio (VCAP mode)*:

1 During playback, touch and hold [◀◀] (Fast-reverse) or [▶▶] (fast-forward).
When touched and held for more than 1 second, the disc is forwarded/reversed at double speed. When held for 5 more seconds or longer, the disc is forwarded/reversed at 8 times the normal speed. When held for 10 seconds or longer, the disc is forwarded/reversed at 21 times the normal speed.

DVD-Audio (VOFF mode)*:

1 During playback, touch and hold [◀◀] (Fast-reverse) or [▶▶] (fast-forward).

2 Stop touching [◀◀] or [▶▶] to return to normal playback.

* When "VCAP" or "VOFF" is set in "Setting of the DVD-Audio Playback Mode" (page 32).

- No sound is played back during fast-forwarding/fast-reversing.
- This operation may not be possible on certain discs.

Finding the Beginnings of Chapters or Tracks

DVD-V DVD-A DVD-VR VCD

During playback, touch [◀◀] or [▶▶].

The chapter/track switches each time the button is touched, and playback of the selected chapter/track starts.

▶▶: Touch this to start playback from the beginning of the following chapter or track.

◀◀: Touch this to start playback from the beginning of the current or previous chapter or track.

- Some DVDs do not have chapters.
- Be sure to turn PBC off before starting the search. (See "Setting the Video CD Play Mode" on page 33.)

Supplementary explanations

"**Chapters**" are divisions of movies or musical selections on DVDs.

"**Tracks**" are divisions of movies or musical selections on Video CD, DVD Audio and music CDs.

"**Groups**" associate a track (one song) with other tracks stored on a DVD-Audio.

Group playback differs, depending on the disc.

"**Playlists**" specify a range of images and their playback order.

Only discs containing a Playlist can be used.

Playing Still Frames (Pausing)

DVD-V DVD-A DVD-VR VCD

1 During playback, touch [▶ / ||].

2 Touch [▶ / ||] to resume playback.

- No sound is played during the still frame mode.
- The image or sound may stop temporarily when playback starts from the pause mode. This is not a malfunction.

Forward/reverse frame-by-frame Playback

DVD-V DVD-VR VCD

1 In the pause mode, touch [◀◀] or [▶▶].

The picture advances or reverses by one frame each time the button is touched.

2 Touch [▶ / ||] to return to normal mode.

- No sound is output during forward/reverse frame-by-frame playback.
- Reverse frame-by-frame cannot be carried out on the DVD-VR and Video CD.

Slow Motion Playback

DVD-V DVD-VR VCD

1 When [**⏪**] or [**⏩**] is touched and held while in the pause mode, the 1/8th speed slow motion playback mode is set.

When held in for 5 more seconds, the slow motion speed switches to 1/2 the normal speed.

2 Stop touching [**⏪**] or [**⏩**] to pause, and touch [**▶**] / [**⏮**] to play back.

- No sound is played during slow motion playback.
- Reverse slow motion playback is not available on the DVD-VR and Video CD.
- 1/2, 1/8 are approximate speeds. The actual speed differs from disc to disc.

Selecting Programme (SKIP) DVD-VR

1 Touch [**P1/3**] twice while playing a DVD-VR disc. The PROGRAM function guide is displayed.

2 Touch PROGRAM* [**▼**] or [**▲**] to select a programme.

* To switch the function guide display PLAYLIST [**▼**] or [**▲**] to PROGRAM [**▼**] or [**▲**], play back the programme. For details, refer to "Searching by Programme" (page 20).

Selecting Playlist (SKIP) DVD-VR

1 Touch [**P1/3**] twice while playing a DVD-VR disc. The PLAYLIST function guide is displayed.

2 Touch PLAYLIST* [**▼**] or [**▲**] to select a playlist.

* To switch the function guide display PROGRAM [**▼**] or [**▲**] to PLAYLIST [**▼**] or [**▲**], play back the playlist. For details, refer to "Searching by Playlist" (page 20).

Repeat Playback

DVD-V DVD-A DVD-VR VCD

Use this function to play the disc's titles, chapters or tracks etc., repeatedly.

DVD Video

1 Touch [**↺**] on the touchscreen.

The repeat mode switches every time the button is touched.

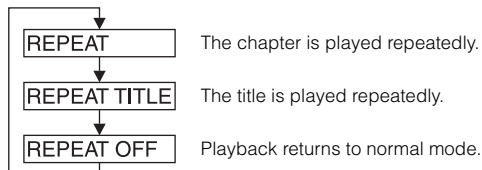

- Display may vary depending on the connected devices.
- The REPEAT mode is always turned off when [**↺**] is touched and held for at least 2 seconds.

Video CD

1 During playback, touch [**↺**] on the touchscreen.

The repeat mode switches every time the button is touched.

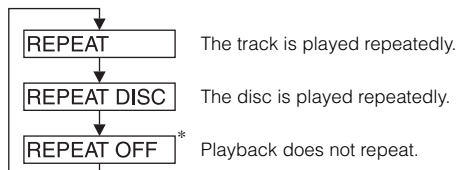

* Displayed only in the changer mode.

- Display may vary depending on the connected devices.
- The track/disc repeat modes cannot be used on Video CDs with playback control (PBC). These modes can be carried out after turning PBC off. See "Setting the Video CD Play Mode" on page 33.
- For some discs it is not possible to switch the repeat mode.

DVD Audio

1 Touch [↶] on the touchscreen.

The repeat mode switches every time the button is touched.

VCAP mode*¹:

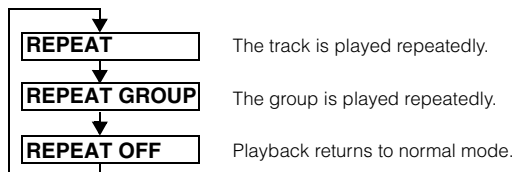

VOFF mode*¹:

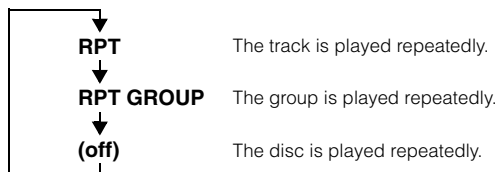

*¹ When “VCAP” or “VOFF” is set in “Setting of the DVD-Audio Playback Mode” (page 32).

DVD-VR

1 Touch [↶] on the touchscreen.

The repeat mode switches every time the button is touched.

The Programme mode*²:

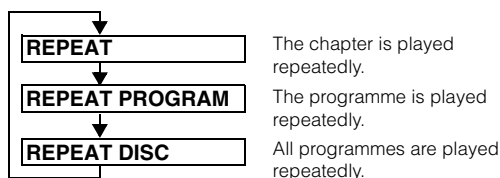

The Playlist mode*²:

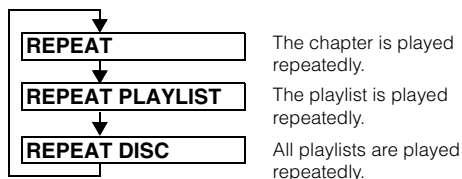

*² To switch the Programme mode display to the Playlist mode display on the DVD mode main screen, play back via programme or playlist search. Refer to “Searching by Programme” or “Searching by Playlist” (page 20).

- Only discs containing a Playlist can be displayed.

Searching by Title/Group/Programme/ Playlist Number

(DVD-V) (DVD-A) (DVD-VR)

Use this function to easily find positions on the DVD using the DVD’s titles, groups, programmes or playlists.

1 Touch [P1/2]* while playback is stopped.

The function guide appears.

* Touch [P1/3] while playing a DVD Audio or DVD-VR disc.

2 Touch [10KEY].

The numeric keypad input mode screen appears.

3 Enter a desired title, group, programme or playlist by touching its title, group, programme or playlist number.

See page 20 for operation of the numeric keypad.

4 Confirm your selection by touching [ENT].

Playback will start from the title number selected.

- To switch the Programme mode display to the Playlist mode display on the DVD mode main screen, play back via programme or playlist search. Refer to “Searching by Programme” or “Searching by Playlist” (page 20).
- This function cannot be used on discs on which no title numbers are recorded.
- Playback starts from the beginning of the chapter/track number in the state of PRE STOP.
- Some disc may not accept any operation.

Searching Directly by Chapter or Track Number

(DVD-V) (DVD-A) (DVD-VR) (VCD)

Use this function to easily move to the beginnings of the chapters or tracks on the disc.

1 Touch [P1/2]* in any mode other than stop mode.

The function guide will appear.

* Touch [P1/3] while playing a DVD-VR disc or DVD-Audio disc.

2 Touch [10KEY].

The numeric keypad input mode screen will appear.

3 Touch and enter the chapter or track number you want to play.

See page 20 for operation of the numeric keypad.

4 Touch [ENT] to confirm your selection.

Playback will start from the selected chapter or track.

- This function is not available for a disc on which chapters or tracks are not stored.
- Be sure to turn PBC off before starting the search. (See “Setting the Video CD Play Mode” on page 33.)
- For a Video CD disc, a track number can be selected even in the stop mode.

Switching the Angle DVD-V DVD-A

On DVDs in which scenes have been filmed from multiple angles, the angle can be switched during playback.

1 During playback, touch **[P1/2]***.

The function guide changes.

* Touch **[P1/3]** while playing a DVD-Audio.

2 Touch **[ANGLE]**.

The angle switches between the angles recorded on the disc every time the button is touched.

- Some time may be required for the angle to change.
- Depending on the disc, the angle may switch in one of two ways.
 - Seamless: The angle switches smoothly.
 - Non-seamless: When the angle is switched, a still picture is displayed first, after which the angle switches.
- To play back a DVD-Audio disc, set "VCAP" in "Setting of the DVD-Audio Playback Mode" (page 32).

Scroll to Move the Page Forward or Back

DVD-A

"Page" is a still image stored on a DVD-Audio disc.

1 Touch **[P1/3]** twice while playing a DVD-Audio disc in VCAP mode*.

* To play back a DVD-Audio disc, set "VCAP" in "Setting of the DVD-Audio Playback Mode" (page 32).

2 Touch **PAGE [▼]** or **[▲]**.

The display switches.

Touch and hold to display the home page.

- For DVD-Audio discs without pages, depending on the DVD-Audio disc, the "Page" function may not be operable if images are in slide show form.

Switching the Audio Tracks

DVD-V DVD-A DVD-VR VCD

DVDs with multiplex audio or audio languages allow switching the sound during playback.

1 During playback, touch **[P1/2]***¹.

*¹ The display differs according to the disc (mode).

2 Touch **[AUDIO]**.

The sound switches between the alternate audio tracks recorded on the disc every time the button is touched.

- The alternate track selected becomes the default setting every time the power is turned on or the disc is replaced. If the disc does not include that track, the disc's default language is selected instead.
- Not all discs will allow changing the alternate audio tracks during playback. In these cases, select audio tracks from the DVDs menu.
- There may be a delay before the selected alternate track begins to play.

Video CDs or DVD-VR disc with multiplex audio

1 During playback, touch **[P1/2]***².

The function guide changes.

*² Touch **[P1/3]** while playing a DVD-VR disc.

2 Touch **[AUDIO]***³.

The left and right channels will be output as shown below, each time the button is touched.

*³ Touch **[AUDIO]** for at least 2 seconds to switch while playing a DVD-VR disc.

AUDIO LL → AUDIO RR → AUDIO LR → AUDIO LL

Switching the Subtitles (Subtitle Language)

DVD-V DVD-A DVD-VR

With DVDs on which multiple subtitle languages are recorded, the subtitle language can be switched during playback; moreover, subtitles can be hidden.

1 During playback, touch [P1/2]*.

The function guide changes.

* Touch [P1/3] while playing a DVD-Audio or DVD-VR disc.

2 Touch [SUBT.].

Touching this button repeatedly selects sequentially the subtitle languages recorded on the disc, and then turns the subtitles OFF.

- To play back a DVD-Audio disc, set "VCAP" in "Setting of the DVD-Audio Playback Mode" (page 32).
- There may be a delay before the selected subtitle appears.
- Not all discs will allow changing the subtitles during playback. In these cases, select subtitles from the DVDs menu.
- The subtitle language selected becomes the default setting every time the power is turned on or the disc is replaced. If the disc does not include that language, the disc's default language is selected instead. However, the subtitle language may differ depending on the disc.
- For some discs, the subtitles will be displayed even when this is set to OFF. However, the subtitle language may differ depending on the disc.
- Switches the subtitles ON/OFF while playing a DVD-VR disc.

Switching from the disc menu

DVD-V DVD-A

For some discs, the audio language, angle and subtitles can be switched from the disc menu.

1 Touch [MENU] or [TOP MENU] to display the menu.

2 Select an item to confirm it.

See "If a menu screen appears" on page 19.

Displaying the Disc Status for DVD/Video CD

DVD-V DVD-A DVD-VR VCD

Use the procedure described below to display the status (title number, chapter number, group number, etc.) of the currently playing DVD or of the currently playing Video CD (track number, etc.) on the monitor.

1 During playback, touch the display panel.

The operation menu screen is displayed.

2 Touch [CONTROL] within 5 seconds.

The display status is displayed for 5 seconds.

- To play back a DVD-Audio disc, set "VCAP" in "Setting of the DVD-Audio Playback Mode" (page 32).

Other Useful Features

Adjusting the Audio

1 Touch [SETUP] on the main source screen.
The SETUP selection screen is displayed.

2 Touch [AUDIO].
The AUDIO SETUP screen appears.

Display Example for Audio Adjustment Screen

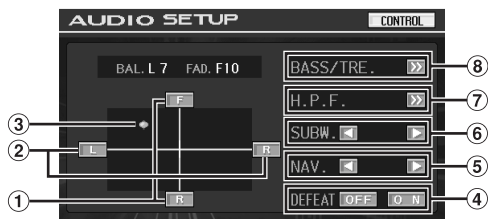

• Touching [CONTROL] will change to the main source screen.

① Adjusting the Fader

Touch [F] or [R] to adjust the volume of the front and rear speakers.

Setting range: F15 to R15

② Adjusting the Balance

Touch [L] or [R] to adjust the sound volume of the left and right speakers.

Setting range: L15 to R15

③ Adjusting the Balance/Fader Directly

Touch and move [○] to a desired setting.

Or touch a desired setting range, and [○] will move to that location.

Touch [L] or [R] of Balance and [F] or [R] of Fader for fine-tuning.

④ Turning Defeat ON or OFF

Touch [ON] or [OFF] of DEFEAT to set to ON or OFF.

If you set the defeat to ON, MX of an external audio processor is turned OFF and EQ is returned to the initial setting.

⑤ Adjusting NAV. Level

Touch [◀] or [▶] of NAV. to adjust the volume of navigation interruption.

Setting range: 0 to 15

- This adjustment becomes available when NAV. MIX is turned on in "Setting the Navigation Interruption" (page 36).
- The setting navigation interruption is not displayed if an external audio processor not compatible with NAV. MIX is connected.

⑥ Adjusting the Subwoofer Level

Touch [◀] or [▶] of SUBW. to adjust the subwoofer output.

Setting range: 0 to 15

- The level adjustment becomes available when subwoofer is turned on in "Subwoofer On and Off" (page 37).

⑦ Adjusting H.P.F. (High Pass Filter)

Touch [➤] to display the H.P.F. adjusting screen.

Touch [◀] or [▶] to adjust the desired speaker.

Setting range: OFF, 80 Hz, 120 Hz, 160 Hz

- Select OFF when no adjustment is required.
- The H.P.F. item is not displayed when an External Audio Processor is connected.

⑧ Adjusting Bass/Treble

You can change the bass/treble frequency emphasis to create your own tonal preference.

Touch [➤] to display the Bass/Treble adjusting screen.

Touch [▲] or [▼] on the scroll bar to scroll the setup items line by line.

- Adjustment cannot be performed when an external audio processor is connected and DEFEAT is set to ON.
- When an external processor is connected, the display changes from "BASS/TRE." to the "A.PROC." item. For "A.PROC." operation, refer to "External Audio Processor (Optional)" on page 41.

Setting the Bass level:

You can emphasize or weaken the bass frequency.

Touch [◀] or [▶] of BASS LEVEL to select the desired bass level.

Setting range: -7 to +7

Setting the Bass Centre Frequency:

The displayed bass frequency is emphasized.

Touch [◀] or [▶] of BASS FREQ to select the desired bass centre frequency.

Setting range: 60 Hz, 80 Hz, 100 Hz, 200 Hz

Setting the Bass Bandwidth:

Changes the boosted bass bandwidth to wide or narrow.

A wider setting will boost a wide range of frequencies above and below the centre frequency. A narrower setting will boost only frequencies near the centre frequency.

Touch [◀] or [▶] of BASS BANDWIDTH to select the desired bass band width.

Setting range: WIDE1 to WIDE4

- The bass level settings will be individually memorised for each source (FM, MW, LW, CD, etc.) until the setting is changed. The bass frequency and bass band width settings adjusted for one source are effective for all other sources (FM, MW, LW, CD etc.).

Setting the treble level:

You can emphasize the treble frequency.

Touch [◀] or [▶] of TREBLE LEVEL to select the desired treble level.

Setting range: -7 to +7

Setting the Treble Centre Frequency:

The displayed treble frequency is emphasized.

Touch [◀] or [▶] of TREBLE FREQ to select the desired treble centre frequency.

Setting range: 10 kHz, 12.5 kHz, 15 kHz, 17.5 kHz

- The treble level settings will be individually memorised for each source (FM, MW, LW, CD, etc.) until the setting is changed. The Treble frequency settings adjusted for one source are effective for all other sources (FM, MW, LW, CD, etc.).

Setting the Loudness:

Loudness introduces a special low- and high-frequency emphasis at low listening levels. This compensates for the ear's decreased sensitivity to bass and treble sound.

Touch [ON] or [OFF] of LOUDNESS to set to ON or OFF.

Search Function

1 Touch [□] on the function guide while in the CD or MP3/WMA mode.

The search list screen is displayed.

Select a desired track or folder.

Touch [▶] for direct playback.

When a hierarchical list is prepared, [>>] will be displayed. Touch [>>] to display the respective hierarchy list screens.

Display Example for Search Screen

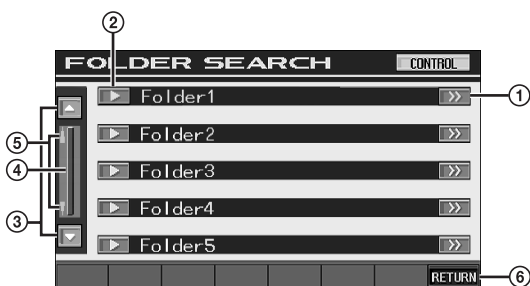

- 1 [>>] is displayed if there is a hierarchical list.
- 2 Select directly by touching [▶], and its track (or folder/file) is played back.
- 3 Scroll the list one paragraph at a time by touching [▲] or [▼].
- 4 Touch and slide up or down to scroll the list backwards or forwards.

- 5 UP/DOWN scroll indicator
Turns orange when the slide bar is used.
 - 6 Touch [RETURN] to return to the previous list screen.
- The search function does not work on the DVD, Video CD or CD changer. (If [TOP MENU] or [MENU] is touched in the DVD-VR mode, the unit changes to the search function. Refer to "Searching by Programme" and "Searching by Playlist" (page 20).)
 - A folder list is displayed only during MP3/WMA playback when the DVD player (DVA-5210) or changer compatible with MP3 is connected.

Internal CD player mode

- 1 The track list* screen appears.
- 2 Touch [▶] of a desired track text*.
The selected track will be played back.
* If the CD is text compatible only.
 - "TRACK" is displayed in the track text list if there is no text on the disc.

Internal MP3/WMA Player/external MP3-compatible DVD Player/Changer Mode

- 1 The folder list screen appears.
Select a desired folder and then touch [>>].
([>>] appears only when a file is present in the selected folder.)
The file list screen is displayed.
 - Touch [▶] to play back the folder directly.
- 2 Touch [▶] of a desired file name.
The selected file will be played back.

Rear Entertainment Function

The rear entertainment function independently routes different sources to the front and the rear inside a car. For example, while listening to the radio or other audio source in the front, DVD can be enjoyed in the rear with the optional rear monitor and headphones.

- 1 Touch [SOURCE] on the main source screen.
The SOURCE selection screen is displayed.
- 2 Touch [REAR].
Rear Select display appears.
 - Touching [MAIN] on the Rear Select screen will change to the main source screen.
- 3 Touch the desired source such as visual (auxiliary input, built-in DVD) to select.
 - Touch [OFF] to cancel the rear entertainment function.
 - When the "Setting the AUX Mode" (page 36) is set to OFF, the auxiliary source is not displayed.

Switching Display Modes

While your vehicle is parked, touch **[WIDE]** on the visual source screen.

Each touch changes the display modes as follows:

MODE 1 → MODE 2 → MODE 3 → MODE 1
(WIDE) (CINEMA) (NORMAL) (WIDE)



In Mode 1 (Wide), the monitor displays a normal picture wider to fit in a wide-screen monitor by evenly stretching out the picture horizontally.



In Mode 2 (Cinema), the monitor displays a normal picture by stretching out the picture horizontally and vertically. This mode is good for displaying a cinema type picture at the 16:9 ratio.



In Mode 3 (Normal), the monitor displays a normal picture at the centre of the screen with a vertical black band at each side.

Switching the Visual Source Only (Visual Select)

You can watch the video portion of another source while listening to the current source.

- 1 Touch [VISUAL] on the audio source screen.**
The VISUAL selection screen appears.
- 2 Touch a desired visual source.**
The visual source is switched to the selected one.

Canceling the Visual Select Function

- 1 Touch the visual screen to display the main control.**
- 2 Touch [CONTROL].**
- 3 Touch [VISUAL] within 5 seconds.**
The VISUAL selection screen appears.
- 4 Touch [NORMAL].**
The simultaneous function is cancelled.

- To make the setting, set to “Setting the VISUAL Soft Button” (page 37).
- If a DVD player is connected, you can receive the DVD picture/sound.

DVD changer (DHA-S680P) is connected:

Press and hold V.OUT on the remote control supplied with the DVD player or DVD changer for more than 2 seconds. The picture and sound of the DVD will be output.

The DVA-5210 is connected:

Press V.OUT on the remote control (included with the DVA-5210) to output DVD picture/sound.

- The simultaneous function cannot be used when the Audio source is in the navigation mode.

When NAV. is set in “Setting the VISUAL Soft Button” (page 37), only the navigation screen can be recalled.

Blackout Mode On and Off

When Blackout mode is turned on, the monitor display will turn off to reduce power consumption.

This additional power enhances the sound quality.

- 1 Touch [VISUAL] on the main source screen.**
The VISUAL selection screen is displayed.
- 2 Touch [OFF].**
The backlit-display portion goes out.
- 3 Touch [OFF] again to cancel the display backlight.**
 - To make the setting, set to “Setting the VISUAL Soft Button” (page 37).
 - If any button on the unit is pressed during Blackout mode, the function will be displayed for 5 seconds to show the operation before returning to Blackout mode.

Setup

DVD Setup

DVD Setup Operation

The Parking Brake must be engaged to access the DVD mode screen. Attempting to access this screen while driving will display the warning-CAN'T OPERATE WHILE DRIVING.

The DVD Setup operation can be carried out after removing the disc from the unit.

The following steps 1 to 5 are common operations to each "Setting item" of DVD Setup. Refer to each section for details.

- 1 Touch [SETUP] on the main source screen.**
The SETUP selection screen is displayed.
- 2 Touch [SOURCE].**
The SOURCE SETUP screen appears.
- 3 Touch [>>] of DVD SETUP.**
The DVD setup screen appears.
- 4 Touch [<<] or [>>], etc., of the desired item to change its setting.**

Setting items:

MENU LANGUAGE / AUDIO LANGUAGE / SUBT. LANGUAGE / COUNTRY CODE / PARENTAL / DIGITAL OUT MODE / DOWNMIX MODE / TV SCREEN / BONUS CODE / DVD-A SETUP / FILE PLAY MODE / PBC

Display example for DVD setup screen

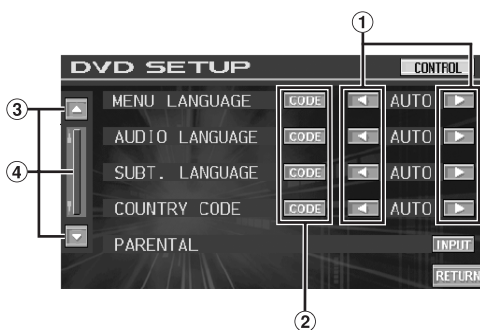

- Touch [<<] or [>>] to set a desired language.
- Touch [CODE] to display the numeric keypad input screen.
- Touch [▲] or [▼] to scroll a setting item list by one line.
- Touch and slide up or down to scroll the list backwards or forwards.

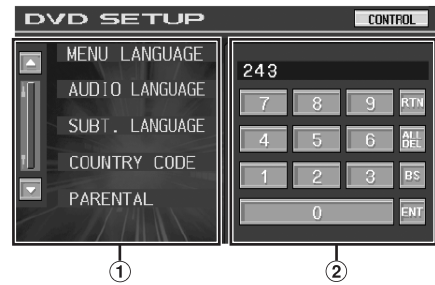

- The numeric keypad input screen closes when the area is touched while displayed.
- Numeric keypad input screen
The numeric keypad is used if you want to play back in a language other than that displayed, or to input your parental lock password, etc.

- 5 Touch [RETURN] to return to the previous screen.**
Touch and hold [RETURN] for at least 2 seconds to return to the main source screen that was displayed before the setup operation was started.

- Immediately after changing the settings of DVD mode (while the system is writing data automatically) do not turn the ignition key (engine key) to OFF.
Otherwise, the settings may not be changed.

Changing the language setting

The audio language, subtitle language and menu language can be set according to your preferences.

Once set, this becomes the default language. This function is convenient when you always want to listen in English. (The language setting is not effective on some discs. If not, the default language is set from the factory.)

- When the settings are changed, the old settings are overwritten. Make a note of the current settings before making changes. The memory is cleared when the vehicle's battery is disconnected.
- To temporarily change the language of the current disc, either do so from the DVD menu or by using the operation described in the section "Switching the Audio Tracks" (page 24).
- If the disc does not include the selected language, the disc's default language is set.

Setting of the Menu Language

Set the language used for the menus (title menu, etc.).

Setting item: MENU LANGUAGE

Setting contents: AUTO / ENGLISH / JAPANESE / GERMAN / SPANISH / FRENCH / ITALIAN / SWEDISH / RUSSIAN / CHINESE

- When "AUTO" is selected, the primary menu language among the recorded ones is played.

Setting of the Audio Language

Set the audio language produced from the speakers.

Setting item: AUDIO LANGUAGE

Setting contents: AUTO / ENGLISH / JAPANESE / GERMAN / SPANISH / FRENCH / ITALIAN / SWEDISH / RUSSIAN / CHINESE

- When "AUTO" is selected, the primary audio language among the recorded ones is played.

Setting of the Subtitle Language

Set the language of the subtitles displayed on the screen.

Setting item: *SUBT. LANGUAGE*

Setting contents: *AUTO / ENGLISH / JAPANESE / GERMAN / SPANISH / FRENCH / ITALIAN / SWEDISH / RUSSIAN / CHINESE*

- When “*AUTO*” is selected, the primary subtitle language among the recorded ones is played.

To play in a language other than those displayed

- 1 Touch [CODE].
The numeric keypad screen is displayed.
- 2 Touch the 4-digit numeral of the language number.
As for the language number, refer to “List of Language Codes” (page 57).
- 3 Touch [ENT] to memorise the number.

Changing the Country Code Setting

Set the country number of which you want to set the rating level (Parental lock).

Setting item: *COUNTRY CODE*

Setting contents: *AUTO / OTHER*

- AUTO:** The primary country code among those recorded is played.
- OTHER:** The setting content changes to “OTHER” if the desired country code is input.

- When the settings are changed, the old settings are overwritten. Make a note of the current settings before making changes. The settings are cleared when the vehicle’s battery is disconnected.

- 1 Touch [CODE].
- 2 Touch [ALL DEL] or [BS].
Delete the displayed country number.
- 3 Touch the 4-digit country code.
As for the country number, refer to “List of Country Codes” (pages 58 and 59).
- 4 Touch [ENT] to memorise the code.

Setting the Rating Level (Parental Lock)

This function can help restrict the viewing of movies to children of appropriate age levels only.

Setting item: *PARENTAL*

Setting content: *INPUT*

- When the settings are changed, the old settings are overwritten. Make a note of the current settings before making changes. The memory is cleared when the vehicle’s battery is disconnected.
- On unrated DVDs, playback will not be restricted even if the rating level is set.
- If you want to play back DVD software with the parental lock feature and its use is currently restricted, change the rating level and the country number in order to play back the DVD.
- Once set, this rating level remains in memory until changed. To enable playback of discs of higher rating levels or to cancel the parental lock, the setting must be changed.
- Not all DVDs provide a Parental Lock feature. If you are unsure about a DVD, play it first to confirm. Do not leave DVDs accessible to young children for whom you deem them inappropriate.

- 1 Touch [INPUT].
The numeric keypad screen is displayed.
- 2 Touch the numeric keypad to input a 4-digit password.
The initial number is 1111.
Input number are displayed as “*”.
- 3 Touch [ENT] to memorise the number.
The PARENTAL screen appears.

Set the rating level of PARENTAL

- 4 Touch [ON] of PARENTAL to turn on.
- 5 Touch [◀] or [▶] of PARENTAL LEVEL to select the rating level (1 to 8).
Select “OFF” to cancel the parental lock or if you do not want to set a rating level. The smaller the number, the higher the rating level.
- 6 Touch [RETURN] to return to the previous screen.

Changing the password

- 4 Touch [INPUT] of PASSWORD CHANGE.
The numeric keypad screen is displayed.
- 5 Touch the input screen to enter a new 4-digit password.

- Keep a note of the number somewhere safe in case you should forget it.

- 6 Touch [ENT] to memorise the number.
- 7 Touch [RETURN] to return to the previous screen.

Changing the rating level temporarily

Some discs may request that you change the rating level set in the default settings during playback. In this case, the message appears on the monitor screen “PARENTAL LEVEL CHANGE OK? [YES] / [NO].”

If this screen appears, change the level as follows:

- **To change parental level and play, touch [YES].**
When [YES] is touched, the numeric keypad input screen is displayed. Input the 4-digit password in “Setting the Rating Level (Parental Lock)” you set, then touch [ENT].
- **To play without changing the parental level, touch [NO].**
(When [NO] is touched, playback will be at the parental level set in “Setting the Rating Level (Parental Lock)”.)

Changing the Digital Output Setting

Use the following procedure to set the digital audio signal output from the IVA-W205R/IVA-W202R.

Setting item: *DIGITAL OUT MODE*

Setting contents: *AUTO / LPCM*

- AUTO:** The digital output is switched automatically according to the type of audio signals being played.
Be sure to select “AUTO” when you want to connect a digital audio processor and play Dolby Digital audio.
“AUTO” is the factory setting.
- LPCM:** The audio signals recorded on the disc are converted to 48 kHz/16 bit (for DVDs) or 44.1 kHz (for Video CDs and CDs) linear PCM audio signals for output.

Audio output/Optical digital audio output

Disc	Audio recording format		Digital output setting (DVD SETUP)	Optical digital audio output	Analogue audio output (Ai-NET, RCA output)
	Format	Fs			
LPCM (CD-DA, DVD-V, DVD- A, DVD-VR)	44.1/176.4 kHz	16/20/24 bit	AUTO or LPCM	44.1 kHz, 16 bit, LPCM 2 ch (2 ch Downmix)*	OK
	48/96/192 kHz	16/20/24 bit	AUTO or LPCM	48 kHz, 16 bit, LPCM 2 ch (2 ch Downmix)*	OK
PPCM (DVD-A)	44.1/88.2/ 176.4 kHz	16/20/24 bit	AUTO or LPCM	Not output	OK
	48/96/192 kHz	16/20/24 bit			
Dolby Digital (-EX) (DVD-V, DVD- A, DVD-VR)	48 kHz	16/18/20 bit	LPCM	48 kHz, 16 bit, Decoded 2 ch (2 chDownmix)*	OK
			AUTO	Auto (Max 7.1 ch)*	OK
DTS (-ES) (CD-DA, DVD-V, DVD- A)	44.1 kHz	16/20/24 bit	LPCM	44.1 kHz, 16 bit Decoded 2 ch (2 chDownmix)*	OK
			AUTO	Auto (Max 6.1 ch)*	OK
	48/96 kHz	16/20/24 bit	LPCM	48 kHz, 16 bit, Decoded 2 ch (2 chDownmix)*	OK
			AUTO	Auto (Max 6.1 ch)*	OK
MPEG1 Layer II (VCD, DVD-V, DVD-A, DVD- VR)	44.1 kHz	16 bit	LPCM	44.1 kHz, 16 bit, Decoded 2 ch*	OK
			AUTO	Auto*	OK
	48 kHz	16 bit	LPCM	48 kHz, 16 bit, Decoded 2 ch (2 chDownmix)*	OK
			AUTO	Auto (Max 5.1 ch)*	OK
MPEG2 Layer II (DVD-V, DVD- A, DVD-VR)	44.1 kHz	16 bit	LPCM	44.1 kHz, 16 bit, Decoded 2 ch*	OK
			AUTO	Auto*	OK
	48 kHz	16 bit	LPCM	48 kHz, 16 bit, Decoded 2 ch (2 chDownmix)*	OK
			AUTO	Auto (Max 5.1 ch)*	OK
MPEG 1/2/ 2.5 Layer III (MP3, WMA)	32 kHz	16 bit	AUTO or LPCM	32 kHz, 16 bit, Decoded 2 ch	OK
	44.1 kHz	16 bit	AUTO or LPCM	44.1 kHz, 16 bit, Decoded 2 ch	OK
	48 kHz	16 bit	AUTO or LPCM	48 kHz, 16 bit, Decoded 2 ch	OK

* Not output when playing back a DVD-Audio.

Setting the Downmix Mode

This function applies to Dolby Digital, DTS stream sound.

Setting item: **DOWNMIX MODE**

Setting contents: **SURROUND / STEREO**

SURROUND: Surround compatible Downmix.

STEREO: Stereo Downmix.

Setting the TV Screen Setting

Use the procedure described below to modify the output screen according to the type of TV monitor (rear monitor) being used. If the rear monitor is not connected, the screen setting is 16:9.

Setting item: **TV SCREEN**

Setting contents: **4:3 LB / 4:3 PS / 16:9**

- For some discs, the picture may not be set to the selected screen size. (For details, refer to the explanation on the disc's jacket.)

4:3 LETTER BOX:

Select this when connected to a conventional 4:3 size (normal TV aspect ratio) monitor. There may be black stripes visible at the top and bottom of the screen (when playing a 16:9 size movie). The width of these stripes will depend upon the original aspect ratio of the theatrical release of the movie.



4:3 PAN-SCAN:

Select this when connected to a conventional 4:3 size monitor. The picture will fill the entire TV screen. However, due to the mismatch in aspect ratio, parts of the movie at the extreme left and right sides will not be visible (when playing a 16:9 size movie).



16:9 WIDE:

Select this when connected to a wide screen TV. This is the factory setting.



Setting of the Bonus Code DVD-A

Some DVD-Audio discs include bonus group.

The 4 digit code for the bonus group can be memorised.

Refer to the information on the jacket, etc., of the disc, for the code number.

Setting item: **BONUS CODE**

Setting contents: **CODE**

- 1 Touch [CODE].**
The 10 key input screen is displayed.
- 2 Input the 4 digit code number given on the jacket of the disc, etc.**
- 3 Touch [ENT] to memorise the number.**

- If the code number of the bonus group differs from the code number you set in this section, the 10 key input screen automatically appears in the display. If a new code number is input, this code number will be replaced.

Setting of the DVD-Audio Playback Mode

DVD-A

To playback the DVD Audio Disc, you have a choice of 3 different settings. If the disc containing DVD Video and Audio, set VCAP (Video Capable Audio Player) or VOFF (Video OFF) to playback the DVD Audio.

Setting item: **DVD-A SETUP**

Setting contents: **VIDEO / VCAP / VOFF**

- VIDEO:** Only DVD Video is played back if the disc contains DVD Video and Audio.
- VCAP:** DVD Audio is played back with Video.
- VOFF:** DVD Audio is played back without Video.

Playing MP3/WMA Data (File Play Mode)

When using discs containing both audio data and MP3/WMA data.

Setting item: FILE PLAY MODE

Setting contents: CD / CPM

- CD: Plays only the audio data on discs containing both audio data and MP3/WMA data.
- CPM: Plays only the MP3/WMA files on discs containing both audio data and MP3/WMA data.

- Insert the disc when playback is stopped and remove the disc from the unit before setting.
- When an MP3-compatible CD changer is used, this setting cannot be applied.

Setting the Video CD Play Mode

When playing a Playback Control (PBC) enabled Video CD, you can choose to set PBC ON or OFF.

Setting item: PBC

Setting contents: ON / OFF

- ON: The PBC menu is displayed.
- OFF: The PBC menu is not displayed.

RADIO Setup

Radio Setup Operation

The Parking Brake must be engaged to access the RADIO mode screen. Attempting to access this screen while driving will display the warning-CAN'T OPERATE WHILE DRIVING.

The following steps 1 to 5 are common operations to each "Setting item" of Radio Setup. Refer to each section for details.

- 1 Touch [SETUP] on the main source screen.**
The SETUP selection screen is displayed.
- 2 Touch [SOURCE].**
The SOURCE SETUP screen appears.
- 3 Touch [>>] of RADIO SETUP.**
The RADIO setup screen appears.
- 4 Touch [OFF], [ON] or [◀], [▶] of the desired item to change its setting.**

Setting items:

RDS CLOCK DISP / FM LEVEL / PI SEEK / RDS REGIONAL / PTY LANGUAGE / PTY31

- 5 Touch [RETURN] to return to the previous screen.**

RDS Time Display

When ON is selected, the clock is adjusted automatically based on the time data sent from the RDS broadcast.

Setting item: RDS CLOCK DISP

Setting contents: OFF / ON

- ON: Adjust the clock automatically based on the time data. In this case, the clock cannot be adjusted manually. To adjust it manually, select OFF.

Adjusting Source Signal Levels

If the difference in volume level between the CD and FM radio is too great, adjust the FM signal level as follows.

Setting item: FM LEVEL

Setting contents: LOW / HIGH

PI SEEK Setting

Setting item: PI SEEK

Setting contents: OFF / AUTO

Receiving RDS Regional (Local) Stations

When OFF is selected, the unit automatically keeps receiving the related local RDS station.

Setting item: RDS REGIONAL

Setting contents: OFF / ON

Switching the Display Language of PTY (Programme Type)

You can select one of the patterns of the display languages.

Setting item: PTY LANGUAGE

Setting contents: GB / NL / F / D / I / E

Setting PTY31 (Emergency Broadcast) Reception

PTY31 (Emergency Broadcast) reception can be set to ON/OFF.

Setting item: PTY31

Setting contents: ON / OFF

- The unit automatically gives priority to an Emergency Broadcast whenever it begins, and interrupts the programme you are currently listening to when PTY31 is set to on.
- The unit will show "ALARM" in the display during PTY31 reception.

GENERAL Setup

General Setup Operation

The Parking Brake must be engaged to access the GENERAL mode screen. Attempting to access this screen while driving will display the warning-CAN'T OPERATE WHILE DRIVING.

The following steps 1 to 4 are common operations to each "Setting item" of GENERAL Setup. Refer to each section for details.

- 1 Touch [SETUP] on the main source screen.**
The SETUP selection screen is displayed.
- 2 Touch [GENERAL].**
The GENERAL SETUP screen appears.
- 3 Touch [OFF], [ON] or [◀], [▶], etc., of the desired item to change its setting.**

Setting items:

CLOCK / CLOCK ADJUST / DAYLIGHT SAVING TIME / DEMONSTRATION / BEEP / AUTO SCROLL / LANGUAGE SELECT / LED DIMMER LEVEL

- 4 Touch [RETURN] to return to the previous screen.**
Touch and hold [RETURN] for at least 2 seconds to return to the main source screen that was displayed before the setup operation was started.

- Immediately after changing the settings of General Mode (While the system is writing data automatically) do not turn the ignition key (engine key) to OFF. Otherwise, the settings may not be changed.

Displaying the Time

The clock indication on the monitor display is turned on or off respectively.

Setting item: CLOCK

Setting contents: OFF / ON

Setting the Time

Setting item: CLOCK ADJUST

Further setting items : HOUR / MINUTE / TIME ADJUST

Setting contents: 0-23 / 0-59 / RESET

HOUR: Adjust the hour.

MINUTE: Adjust the minute.

RESET: If the clock shows less than 30 minutes past, the minute will be ": 0"; more than 30, the hour advances.

- The clock-adjusting mode is cancelled when the power is turned off, when [RETURN] or [CONTROL] is touched.
- Clock adjustment can be made when "RDS Time Display" (page 33) is set to OFF.

Setting Daylight Saving Time

Setting item: DAYLIGHT SAVING TIME

Setting contents: OFF / ON

OFF: Return to the ordinary time.

ON: Place the Summer Time mode ON. The time advances by one hour.

Demonstration Function

This unit is equipped with a demonstration function capable of showing basic operations of respective sources on the monitor display.

Setting item: DEMONSTRATION

Setting contents: OFF / ON

OFF: Turns off the demonstration mode.

ON: Turns on the demonstration mode to show the basic operations.

- The demonstration operation is automatically repeated until the function is turned off.

Sound (Beep) Guide Function

Setting item: BEEP

Setting contents: OFF / ON

OFF: Deactivate the Sound Guide mode. The sound guide beep will not be produced when a button on the unit is pressed.

ON: Activate the Sound Guide mode.

Setting the Scroll

Scroll display is available if CD text, folder name, file name or tag information is entered.

Setting item: AUTO SCROLL

Setting contents: OFF / ON

OFF: Turns off the AUTO scroll mode.

Scroll display is done once as a track is changed.

ON: Turns on the AUTO scroll mode. Scroll display is repeated as long as the mode is turned on.

- The display scrolls on the unit when the screen is filled up.
- Song, artist and album name, etc. scrolls when an iPod is connected.

Switching to the Russian Font

Two types of font can be selected.

Setting item: LANGUAGE SELECT

Setting contents: MODE1 / MODE2

MODE1: Normal Font Display (ISO8859-1).

MODE2: Russian Font Display (WINDOWS-1251)

You cannot use this font for display in RDS, Tuner mode.

Adjusting the Dimmer of Button Lighting at Night

You can adjust the brightness of the button lighting at night with the dimmer.

Setting item: LED DIMMER LEVEL

Setting level: -2 to +2

- The adjustment is available when ON is set in "Setting the Brightness of the Backlighting" (page 38).

SYSTEM Setup

System Setup Operation

The Parking Brake must be engaged to access the SYSTEM mode screen. Attempting to access this screen while driving will display the warning-CAN'T OPERATE WHILE DRIVING.

The following steps 1 to 4 are common operations to each "Setting item" of SYSTEM Setup. Refer to each section for details.

- 1 Touch [SETUP] on the main source screen.**
The SETUP selection screen is displayed.
 - 2 Touch [SYSTEM].**
The SYSTEM SETUP screen appears.
 - 3 Touch [◀], [▶] or [OFF], [ON], etc., of the desired item to change its setting.**
- Setting items:**
IN INT. MUTE / IN INT. ICON / REMOTE SENSOR*⁴ / CAMERA IN / NAV. IN / NAV. MIX*⁵ / AUX IN / AUX IN LEVEL *¹ / AUX IN SIGNAL *¹ / AUX OUT / BLUETOOTH IN / USB ADAPTER / VISUAL KEY*² / OPTICAL OUT / SUBWOOFER*³
- *¹ Not displayed when OFF is set in "Setting the AUX Mode" (page 36).
*² Not displayed when OFF is set in "Setting the Navigation Mode" (page 36).
*³ Not displayed when an external audio processor is connected.
*⁴ When ON is set in "Setting the Picture Output" (page 36), the item is displayed.
*⁵ When ON is set in "Setting the Navigation Mode" (page 36), the item is displayed.
- 4 Touch [RETURN] to return to the previous screen.**
Touch and hold [RETURN] for at least 2 seconds to return to the main source screen that was displayed before the setup operation was started.
- Immediately after changing the settings of System Mode (while the system is writing data automatically) do not turn the ignition key (engine key) to OFF. Otherwise, the settings may not be changed.

Setting the External Device Interrupt Mode

If an Alpine Ai-NET Interrupt Box (NVE-K200) is connected to the IVA-W205R/IVA-W202R, an Auxiliary Source will be allowed to interrupt the current audio source. For example, you can listen to the voice guidance of your navigation system when it occurs even while you are playing a CD or DVD. The CD/DVD player will be automatically muted during voice guidance. For further details, please refer to the manual for NVE-K200.

Setting item: IN INT. MUTE

Setting contents: OFF / ON

- OFF: The volume level can be adjusted in Interrupt mode.
- ON: Sound will not be output. The icon that is set in "Setting the Interrupt Icon Display" is displayed.

- The auxiliary device being connected must have an Interrupt wire with a negative trigger for this function to operate automatically. Otherwise, a separate switch needs to be added to switch it manually.

Setting the Interrupt Icon Display

The unit can display the icon of an external device, such as a telephone, whenever a phone call comes in to tell you there is a phone call.

Setting item: IN INT. ICON

Setting contents: INT / TEL

- INT: The INT icon appears on the display.
- TEL: When the external device (telephone) sends the interrupt signal, the telephone icon appears on the display.

Switching the function of the remote sensor

For optional remote control operation, the remote sensor of the external device (monitor, etc.) can be switched, as you prefer.

Setting items: REMOTE SENSOR

Setting contents: FRONT / REAR

- FRONT: The remote sensor of this unit is effective.
- REAR: The remote sensor of the external monitor connected to AUX OUT of this unit becomes effective. The remote control operates the source connected to the AUX OUT terminals.

- If a touch panel rear monitor (connected to the Alpine rear monitor output via the Monitor control lead) is touched, the command is executed regardless of the remote control sensor switch setting. Note, however, that the remote control sensor that has been set takes priority if it has been 5 seconds since last touching the panel.
- When an optional DVD changer or DVD player is connected, and the remote control sensor is set to REAR, some soft button operations ([■] STOP, etc.) cannot be performed. In this case, set the remote control sensor to FRONT.

Setting the Rear Camera Input

With a rear camera connected, rear view video is output to the monitor.

Setting item: CAMERA IN

Setting contents: OFF / NTSC/PAL

- OFF:** The CAMERA source is not displayed on the VISUAL selection screen.
- NTSC/PAL:** Even if the shift lever is not set to reverse (R), the rear pictures are output by selecting the CAMERA source.

- *By shifting to reverse (R), the rear pictures are output. This function is effective when the reverse wire is properly connected.*
- *To apply the setting, set to VISUAL "Setting the VISUAL Soft Button" (page 37).*

Setting the Navigation Mode

When you connect an optional navigation equipment, set it to ON.

Setting item: NAV. IN

Setting contents: OFF / ON

- OFF:** Navigation source is not displayed. The settings related to the navigation cannot be changed from this unit.
- ON:** Navigation source is displayed.

Setting the Navigation Interruption

With an Alpine navigation system connected to the IVA-W205R/ IVA-W202R, the voice guidance of the navigation system will be mixed with the radio or CD play.

Setting item: NAV. MIX

Setting content: OFF / ON

- OFF:** The navigation interruption mode is turned off.
- ON:** The navigation interruption mode is on.

See "Adjusting NAV. Level" under "Adjusting the Audio" on page 26 to set the navigation interruption volume level.

- *The volume level for voice prompts during navigation guidance is set by adjusting its volume while the prompts are announced. When the announcement finishes, the normal audio volume and the previous audio screen are restored. The voice prompt volume is always at or below the current listening volume. If a navigation announcement cuts in while adjusting the audio level, it always resets to the current level regardless of the audio level setting.*
- *This setting is effective when NAV. IN of SYSTEM list screen is ON.*

Setting the AUX Mode

Setting item: AUX IN

Setting contents: OFF / ON / VCR / GAME / TV / DVB-T / EXT. DVD / BLACKBIRD

- OFF:** AUX source is not displayed.
- ON:** AUX source is displayed.

- *OFF is not displayed when the optional DVD player or DVD changer is connected.*
- *When OFF is selected, the settings related to AUX cannot be changed from this unit.*
- *The selected source name is displayed instead of AUX source name. Select SOURCE to switch to the guide function of each mode.*
- *Only when an Alpine TV tuner is connected, you can operate the displayed function guide from this unit.*

Adjusting the External Input Audio Level

After setting to ON in "Setting the AUX Mode," this setting can be carried out.

Setting item: AUX IN LEVEL

Setting contents: LOW / HIGH

- LOW:** Decreases the external input audio level.
- HIGH:** Increases the external input audio level.

Switching the Visual Input Signal System

After setting to ON in "Setting the AUX Mode," this setting can be carried out.

Setting item: AUX IN SIGNAL

Setting contents: NTSC / PAL

- *The video input type can be changed.*

Setting the Picture Output

Outputs the picture of the source selected on the IVA-W205R/IVA-W202R connected to the rear monitor.

Setting item: AUX OUT

Setting contents: OFF / ON

- OFF:** The "REAR" item is not displayed on the Source Selection screen.
- ON:** The "REAR" item is displayed on the Source Selection screen. Touch [REAR] to change to the REAR select screen, then touch the desired source. The selected source picture is output on the rear monitor.

Setting the Bluetooth Connection (BLUETOOTH IN)

Setting item: BLUETOOTH IN

Setting contents: NAV. (IVA-W205R only) / ADAPTER / OFF

- NAV.: Select when the optional portable navigation is connected.
(IVA-W205R only) The TEL screen of the portable navigation is displayed.
- ADAPTER: Select when the optional Bluetooth box is connected.
The TEL screen of the Bluetooth is displayed.
When an external interruption occurs, the display changes to the TEL screen.
- OFF: Select to ignore any external interrupts.

- The setting cannot be made when "Setting the External Device Interrupt Mode" (page 35) is set to ON.
- For details on Bluetooth operation, refer to the Owner's Manual of the Bluetooth Box.

Setting the USB Adapter (KCA-620M) to ON/OFF

If a USB Adapter is to be used, set to ON.

Setting item: USB ADAPTER

Setting contents: OFF / ON

- OFF: Does not display the USB source name on the SOURCE select screen.
- ON: Displays the USB source name on the SOURCE select screen.
- If ON is set even when a CD changer is connected, the source name on the SOURCE select screen will change from CD CHG to USB.

Setting the VISUAL Soft Button

Setting item: VISUAL KEY

Setting contents: VISUAL / NAV.

- VISUAL: Recalls the VISUAL Select screen by touching [VISUAL].
- NAV.: Switches directly to the navigation screen by touching [VISUAL].

Setting the Digital Output

To connect an audio processor using the optical digital output, set to "ON" by the following procedure.

Setting item: OPTICAL OUT

Setting contents: OFF / ON

- Afterwards, set ACC to OFF once, then turn it ON again. The setting of Digital Output is decided.

Subwoofer On and Off

Setting item: SUBWOOFER

Setting contents: ON / OFF

- ON: Subwoofer output is on.
- OFF: Subwoofer output is off.

DISPLAY Setup

Display Setup Operation

The Parking Brake must be engaged to access the DISPLAY mode screen. Attempting to access this screen while driving will display the warning-CAN'T OPERATE WHILE DRIVING.

The following steps 1 to 4 are common operations to each "Setting item" of DISPLAY Setup. Refer to each section for details.

- 1 Touch [SETUP] on the main source screen.**
The SETUP selection screen is displayed.
- 2 Touch [DISPLAY].**
The DISPLAY SETUP screen appears.
- 3 Touch [◀], [▶] or [≫], etc., of the desired item to change its setting.**

Setting items:

TILT* / VISUAL EQ / DIMMER / DIMMER LOW LEVEL / BACKGROUND / AUTO BACKGROUND / DATA DOWNLOAD / BASE COLOR / PULSETOUCH / SCREEN ALIGNMENT

* IVA-W202R only:

For operation, refer to "Adjusting the Monitor Viewing Angle" on page 10.

- 4 Touch [RETURN] to return to the previous screen.**
Touch and hold [RETURN] for at least 2 seconds to return to the main source screen that was displayed before the setup operation was started.
- Immediately after changing the settings of Display Mode (While the system is writing data automatically) do not turn the ignition key (engine key) to OFF. Otherwise, the settings may not be changed.

Setting the Brightness of the Backlighting

Backlighting is provided by a fluorescent light built into the liquid crystal panel. The illumination control adjusts the brightness of the backlighting based on the car ambient lighting for easier viewing.

Setting item: DIMMER

Setting contents: OFF / ON / AUTO

- OFF: Deactivate Auto Dimmer mode to keep the background illumination of the monitor bright.
- ON: Keep the background illumination of the monitor dark.
- AUTO: Adjust the brightness of the background illumination of the monitor automatically to the brightness of the car interior.

- When ON or AUTO is set, the setting is also applied for the button lighting in "Adjusting the Dimmer of Button Lighting at Night" (page 35).

Adjusting the Minimum Level of Backlight

You can adjust the brightness of the backlight (LOW). This function could be used, for instance, to change the screen brightness while travelling at night.

Setting item: DIMMER LOW LEVEL

Setting content: -15 to +15

You can adjust the level between MIN (-15) and MAX (+15). When it reaches the minimum or maximum point, the display shows "MIN" or "MAX" respectively.

Switching Background Textures

You have a choice of background textures you can set.

Setting item: BACKGROUND

Setting contents: MODE1 / MODE2

- This operation can be carried out after removing the disc from the unit or when playback of the disc has stopped.
- Wallpapers downloaded from "Downloading the BACKGROUND data" (page 40) are recalled.
- When you select a source other than the built-in disc on this unit, and the built-in disc is selected on the rear monitor connected to the unit, background textures cannot be displayed on the unit.
- When an error message is displayed (ERROR, HI-TEMP, etc.), background textures selected by this setting cannot be displayed on the unit.

Setting Automatic Wallpapers

The background picture will automatically change each time the ignition key is turned off and turned back on again.

Setting item: AUTO BACKGROUND

Setting contents: OFF / ON

- OFF: Turn off the Auto Background mode.
- ON: Turn on the Auto Background mode.
The background picture will change when the ignition key is turned off once and turned back on again as follows:
MODE1 ↔ MODE2

- Wallpapers downloaded from "Downloading the BACKGROUND data" (page 40) are recalled.

Switching the Font Back Display Colour

You can choose from 5 different display colours for the font back (source title, shortcut display, etc.).

Setting item: BASE COLOR

Setting content: MODE 1 to MODE 5

Turning the Touch Panel Vibration ON or OFF

You can turn the touch panel's vibration ON or OFF during operation.

Setting item: PULSETOUCH

Setting contents: OFF / ON



- OFF: Turns off vibration during operation.
- ON: Turns on vibration during operation.

Adjusting the Touch Panel

Adjustment becomes necessary when the display position on the LCD and the touch position on the touch panel do not match.

Setting item: SCREEN ALIGNMENT

Setting contents:  / RESET

- 1 Touch [] of SCREEN ALIGNMENT.
The adjustment screen appears.
- 2 Accurately touch the  mark provided in the lower left corner of the screen.
The screen changes to the adjustment screen.
- 3 Accurately touch the  mark provided in the upper right corner of the screen.
This completes adjustment, and returns to the DISPLAY setup mode screen.

- If you have touched a location other than the  mark, touch [RESET] to restore the adjustment screen to the initial setting.
- If you touch [RETURN] on the adjustment screen, no adjustment is done and the DISPLAY setup screen is restored.

VISUAL EQ™

Visual EQ Setting Operation

The following steps 1 to 4 are common operations to each "Setting item" of VISUAL EQ setting. Refer to each section for details.

- 1 After steps 1 and 2 in "Display Setup Operation" (page 37) have been performed, touch [>>] of VISUAL EQ.**
VISUAL EQ screen appears.
- 2 Select a desired setting item by touching [▲] or [▼].**
Setting items:
VISUAL EQ* ↔ BRIGHT ↔ COLOR* ↔ TINT* ↔ CONTRAST
↔ SHARP* ↔ USER MEMORY*
- 3 Change the setting on the selected item by touching its [◀] or [▶].**
- 4 Touch [RETURN] to return to the previous screen.**
Touch and hold [RETURN] for at least 2 seconds to return to the main source screen that was displayed before the setup operation was started.

Selecting the VISUAL EQ Mode (Maker's setting)

You can select a mode suitable for the subject image.

Setting item: VISUAL EQ

Setting contents: OFF (FLAT) / NIGHT M. / SOFT / SHARP / CONTRAST / P-1 / P-2

- OFF (FLAT):** Initial Setting.
- NIGHT M.:** Suitable for movies in which dark scenes frequently appear.
- SOFT:** Suitable for CGs and animated films.
- SHARP:** Suitable for old movies where images are not clearly shown.
- CONTRAST:** Suitable for recent movies.
- P-1:** Recalls the VISUAL EQ mode being stored on preset No.P-1 from "Storing VISUAL EQ" (page 40).
- P-2:** Recalls the VISUAL EQ mode being stored on preset No.P-2 from "Storing VISUAL EQ" (page 40).

- To return to the initial setting after selecting any one of the setting contents (NIGHT M. to CONTRAST) and adjusting a desired brightness, picture tint, etc., set this function to OFF.
- If your desired brightness, picture tint, etc., are adjusted after selecting any one of the setting contents (NIGHT M. to CONTRAST), "CUSTOM" is displayed.

Adjusting Brightness

Setting item: BRIGHT

Setting content: -15 ~ +15

You can adjust the brightness between MIN (-15) and MAX (+15). When it reaches the minimum or maximum point, the display shows "MIN" or "MAX" respectively.

- When any Visual EQ Preset is selected, the brightness is automatically adjusted according to the car's interior lighting as long as AUTO is set in "Setting the Brightness of the Backlighting" (page 38).

Adjusting Colour of Picture

Setting item: COLOR

Setting content: -15 ~ +15

You can adjust the colour between MIN (-15) and MAX (+15). When it reaches the minimum or maximum point, the display shows "MIN" or "MAX" respectively.

- Colour adjustment can be made only in the navigation, DVD, Video CD, AUX modes.
- Colour adjustment cannot be made if a Navigation system with the RGB feature is connected.

Adjusting Tint of Picture

Setting item: TINT

Setting content: G15 ~ R15

Adjust the colour from G15 to R15. "G MAX" or "R MAX" is displayed at the maximum of each colour.

- *Tint adjustment can be made only in the navigation, DVD, Video CD, AUX modes.*
- *Tint adjustment cannot be made if a Navigation system with the RGB feature is connected.*
- *When Setting PAL, you cannot adjust the TINT.*

Adjusting Image Contrast

Setting item: CONTRAST

Setting content: -15 to +15

Contrast adjustment range is -15 to +15. "LOW" and "HIGH" appear as the minimum and maximum values specified.

Adjusting Picture Quality

Setting item: SHARP

Setting content: -15 to +15

Picture quality adjustment range is -15 to +15. "SOFT" and "HARD" appear as the minimum and maximum values specified.

- *Picture quality adjustment can be made only in the navigation, DVD, Video CD, AUX modes.*
- *Picture quality adjustment cannot be made if a Navigation system with the RGB feature is connected.*

Storing VISUAL EQ

You can store the settings made for "Adjusting Image Brightness, Tint, Depth, Picture Quality and Contrast."

Setting item: USER MEMORY

Setting contents: P-1 / P-2

- 1 After completing "Adjusting Image Brightness, Tint, Depth, Picture Quality, and Contrast" (pages 39-40), touch [◀] or [▶] of USER MEMORY and then select preset No. "P-1" or "P-2" to which the settings are to be stored.
 - 2 After selecting a preset No., touch [MEMORY].
The adjusted VISUAL EQ mode is stored by the above operations.
- *You can recall the VISUAL EQ mode stored here from P-1 or P-2 of "Selecting the VISUAL EQ Mode (Maker's setting)" (page 39).*

Data Download

Downloading the BACKGROUND data

You can download data (from Alpine's website) to a CD-R/CD-RW (data is written in the root folder), and store the data to the IVA-W205R/IVA-W202R.

To start BACKGROUND download, access the URL below and follow the on-screen instructions.

<http://www.alpine.com> or <http://www.alpine-europe.com>
or <http://www.alpine.com.au>

- 1 **Insert the CD-R/CD-RW disc containing the data you need.**
 - 2 **Touch [◀] or [▶] of DATA DOWNLOAD, then select USER1 or USER2.**
The selected wallpaper can be changed.
 - 3 **Touch [≫] of DATA DOWNLOAD.**
Data search of the disc starts. After completing the data search, the file selection screen of Data Download is displayed.
 - 4 **Touch [▲] or [▼] to select the desired file name.**
 - 5 **Touch [MEMORY].**
Data download starts.
When data downloading has completed correctly, the screen returns to the DATA DOWNLOAD screen.
 - 6 **Touching [RETURN] returns to the previous screen.**
Touch and hold [RETURN] for at least 2 seconds returns to the earlier main source screen.
- *For details about procedures of download, see ALPINE's Web site.*
 - *If data is newly downloaded, the data overwrites the previous data.*
 - *The downloaded data will not be deleted even when the battery power cable is removed.*
 - *You can recall a wallpaper in "Switching Background Textures" (page 38), or "Setting Automatic Wallpapers" (page 38).*
 - *When download has completed, remove the disc.*

Connection of an External Device

External Audio Processor (Optional)

When an external audio processor is connected to this unit, you can operate it from this unit. Some audio processors may not be operated. In this case, operate them in the connected product. Explanations below are the case when PXA-H700 or PXA-H701 is connected for example. Refer also to the operating instructions of the connected audio processor.

- *The adjustments or settings performed on the connected audio processor cannot be operated properly from this unit.*
- *The setting "Setting the Speakers", "Setting Bass Sound Control", and "Graphic Equalizer Adjustments" are not available if the MRA-D550 is connected. Additionally, if the MRA-F350 is connected, the following setting "Setting the MX mode" is not available. Also, the setting content differs between the PXA-H700 and PXA-H701.*
- *This unit cannot be connected to the PXA-H510 and PXA-H900.*

The Parking Brake must be engaged to access the Audio Processor mode screen. Attempting to access this screen while driving will display the warning-CAN'T OPERATE WHILE DRIVING.

Adjustment Procedure for Dolby Surround

Make the adjustments described below in order to reproduce Dolby Digital and DTS sound with greater accuracy.

Adjustment procedure

- 1 Speaker Setup (page 46)**
(Turning the speakers to be used on and off and setting their response)

↓

- 2 Adjusting the speaker levels (page 47)**
(Adjusting the signal output level to the various speakers)

↓

- 3 Mixing bass sound to the rear channel (page 47)**
(Achieving smooth sound in the rear seat by mixing the front audio signals with the rear speaker signals)

↓

- 4 Adjusting the acoustic image (page 47)**
(Adjusting the acoustic image to achieve a sound as if the centre speaker were directly in front of the listener)

↓

- 5 Achieving powerful high volume sound (page 47)**
(Achieving energetic sound with even greater power, like the sound in a movie theater)

↓

- 6 Adjusting the DVD Level (page 48)**
(Adjust the volume (signal level) in the Dolby Digital, Pro Logic II, DTS and PCM modes)

↓

- 7 Storing Settings in the Memory (page 48)**
(Storing all the settings and adjustments made on the IVA-W205R/IVA-W202R (not only the above settings/adjusts) in the memory)

In case of combining the Automatic adjustments etc.

We recommend to make the Automatic adjustments before the Dolby Surround adjustments.

Setting the Speakers

- 1 Check that Defeat mode is off (page 26).**
- 2 Touch [SETUP] on the main source screen.**
The SETUP selection screen is displayed.
- 3 Touch [AUDIO].**
The AUDIO SETUP screen appears.
- 4 Touch [>>] of A.PROC.**
The A.PROCESSOR list screen appears.
- 5 Touch [>>] of SPEAKER SELECT.**
The SPEAKER SELECT screen appears.
- 6 Set the connected speaker by touching the respective [◀], [▶] or [ON], [OFF] button.**

FRONT1:	OFF/FULL (Full Range)/TW (Tweeter)
FRONT2:	OFF/ON
REAR:	OFF/ON
CENTER:	OFF/ON
SUBW.:	OFF/MONO/STEREO
- 7 Touch [RETURN] to return to the previous screen.**
 - Set the speaker which is not connected to OFF.
 - Settings above can be carried out even when the speaker is set to OFF in "Speaker Setup" (page 46).
 - To use the subwoofer in MONO with PXA-H700 or PXA-H701 connected, connect the subwoofer to the subwoofer output terminal of PXA-H700 or PXA-H701.

Set MX Mode of the External Audio Processor

Before performing the operations below, set MX (Media Xpander) mode of the PXA-H700 to "AUTO" when the PXA-H700 is connected.

- 1 Check that Defeat mode is off.**
- 2 Touch [SETUP] on the main source screen.**
The SETUP selection screen appears.
- 3 Touch [AUDIO].**
The AUDIO SETUP screen will appear.
- 4 Touch [>>] of A.PROC.**
The A.PROCESSOR list screen appears.
- 5 Select ON or OFF of MX by touching [ON] or [OFF] of MEDIA XPANDER.**

OFF: Turns off the MX effect of every music source.
ON: Turns on the specified MX mode.
- 6 Touch [>>] after setting to ON.**
The MEDIA XPANDER setup screen appears.

7 Touch [◀] or [▶] of the desired MX mode.

- Music source (such as radio broadcasts and CDs, excluding MW, LW radio) level can be set.

MX CD (OFF, CD MX 1 to 3)

CD mode processes a large quantity of data. This data is used to reproduce the sound clearly by making use of the data quantity.

MX CMPM (OFF, CMPM MX 1 to 3)

This corrects information that was omitted at the time of compression. This reproduces a well-balanced sound close to the original.

MX FM (OFF, FM MX 1 to 3)

The medium to high frequencies become more clear and produces well balanced sound in all the bands.

MX DVD (OFF, MOVIE MX 1 to 2)

The dialog portion of the video is reproduced more clearly.

(DVD MUSIC)

This disc contains a large quantity of data such as music clip. MX uses this data to reproduce the sound accurately.

MX AUX (OFF, CMPM MX, MOVIE MX, MUSIC MX)

Choose the MX mode (CMPM, MUSIC, or MOVIE) that corresponds to the media connected.

8 Touch [RETURN] to return to the previous screen.

- The contents of MX set here is reflected to PXA-H700 or PXA-H701.
- When OFF is selected, MX effect of each MX mode will be OFF.
- Each music source, such as radio, CD, and MP3 can have its own MX setting.
- MX mode does not function when MX is ON for MW, LW radio.
- MX CMPM is applied for MP3/WMA and iPod.
- The MX setting can be performed only when a source is currently selected.

X-OVER Adjustment

- 1 **Check that Defeat mode is off.**
- 2 **Touch [SETUP] on the main source screen.**
The SETUP selection screen appears.
- 3 **Touch [AUDIO].**
The AUDIO SETUP screen will appear.
- 4 **Touch [>>] of A.PROC.**
The A.PROCESSOR list screen appears.
- 5 **Touch [<<] or [>>] of X-OVER to select L/R or L+R.**
L/R: Different adjustment values can be set for the left and right channels.
L+R: Sets the same adjustment values for the left and right channels.
- 6 **Touch [>>] of X-OVER.**
A speaker list on the X-OVER screen is displayed.
- 7 **Touch [>>] of the speaker to be adjusted.**
The screen changes to the X-OVER screen to be adjusted.
- 8 **Adjust the crossover to your preference.**

Selecting the Cut-Off Frequency

Touch [<<] or [>>] of FREQ. then select the cut-off frequency (crossover point).

The adjustable bandwidth differs depending on the speaker (channel).

Adjusting the Level

Touch [<<] or [>>] of LEVEL, then adjust the HPF or LPF level.

Adjusting the Slope

Touch [<<] or [>>] of SLOPE, then adjust the HPF or LPF slope.

- 9 **Touch [RETURN] to return to the previous screen.**

- When the speaker is set to the "OFF" mode, the X-OVER for that speaker cannot be set. Refer to "Setting the Speakers" (page 42).
- Check the playback frequencies of the connected speakers before adjusting.
- In order to protect the speakers, there is no OFF setting for the subwoofer low pass filter (the slope remains the same).
- The HPF cannot be set SLOPE to OFF if Tweeter (TW) is selected for FRONT1. Or, only the subwoofer is adjustable if STEREO is selected for the subwoofer.

Performing Time Correction Manually (TCR)

Because of the particular conditions inside the vehicle, there can be major differences in the distances between the various speakers and the listening position. It is possible to calculate the optimum correction values and eliminate the time error at the listening position yourself using this function.

- 1 **Check that Defeat mode is off.**
- 2 **Sit in the listening position (the driver's seat, for example) and measure the distance (in meters) between your head and the various speakers.**
- 3 **Calculate the difference in distance between the farthest speaker and the other speakers.**

$$L = \begin{array}{l} \text{(distance of farthest speaker)} \\ - \text{(distance of other speakers)} \end{array}$$

- 4 **Divide the distances calculated for the different speakers by the speed of sound (343 m/s temperature 20°C).**

This value is the time correction value for the various speakers.

Concrete examples

Calculating the time correction value for the front left speaker on the diagram below.

Conditions:

Distance between farthest speaker and listening position:

$$2.25 \text{ m (88-3/4")}$$

Distance between front left speaker and listening position:

$$0.5 \text{ m (20")}$$

Calculation:

$$L = 2.25 \text{ m (88-3/4")} - 0.5 \text{ m (20")} = 1.75 \text{ m (68-3/4")}$$

$$\text{Compensation time} = 1.75 \div 343 \times 1000 = 5.1 \text{ (ms)}$$

In other words, setting the time correction value for the front left speaker to 5.1 (ms) sets a virtual distance matching the distance to the farthest speaker.

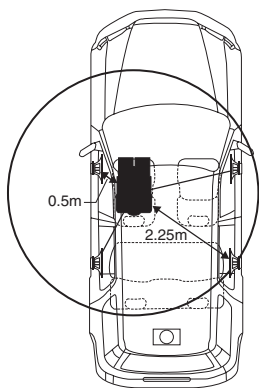

The sound is uneven because the distance between the listening position and the different speakers is different. The difference in the distance between the front left and rear right speakers is 1.75 meters (68-3/4").

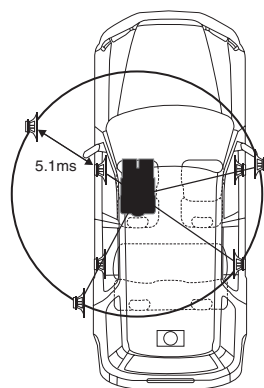

Time correction eliminates the difference between the time required for the sound from the different speakers to reach the listening position. Setting the time correction of the front left speaker to 5.1 ms makes it possible to coordinate the distance from the listening position to the speaker.

5 Touch [SETUP] on the main source screen.
The SETUP selection screen appears.

6 Touch [AUDIO].
The AUDIO SETUP screen appears.

7 Touch [>>] of A.PROC.
The A.PROCESSOR list screen is displayed.

8 Touch [◀] or [▶] of T.CORR.
Select L/R or L+R.

L/R: Different adjustment values can be set for the left and right channels.

L+R: Sets the same adjustment values for the left and right channels.

9 Touch [>>] of T.CORR.
The T.CORR adjustment screen appears.

10 Adjust the time correction value (0.00 ~ 20.00ms) of a desired speaker by touching the respective [◀] or [▶] button (1 step = 0.05ms).

11 Touch [RETURN] to return to the previous screen.

- When the speaker is set to the "OFF" mode, the TCR for that speaker cannot be set. Refer to "Setting the Speakers" (page 42).
- The adjustment value for FRONT2 (speakers) which is adjusted in time correction, is also applied to the front speakers in "Setting Bass Focus" (page 46).
- The adjustment (AUTO TCR) cannot be automatically set on this unit.

Phase Switching

1 Check that Defeat mode is off (page 26).

2 Touch [SETUP] on the main source screen.
The SETUP selection screen is displayed.

3 Touch [AUDIO].
The AUDIO SETUP screen appears.

4 Touch [>>] of A.PROC.
The A.PROCESSOR list screen is displayed.

5 Touch [>>] of PHASE.
The PHASE adjustment screen appears.

6 Switch the phase (0° or 180°) by touching [◀] or [▶] of the desired speaker.

7 Touch [RETURN] to return to the previous screen.

Graphic Equalizer Adjustments

The graphic equalizer allows you to modify the sound using 31 bands each for the front (left and right), rear (left and right) and centre speakers. An additional 10 bands are available for the subwoofer. This allows you to customize the sound to suit your taste.

1 Check that Defeat mode is off.

2 Touch [SETUP] on the main source screen.
The SETUP selection screen appears.

3 Touch [AUDIO].
The AUDIO SETUP screen will appear.

4 Touch [>>] of A.PROC.
The A.PROCESSOR list screen appears.

5 Select L/R or L+R by touching [◀] or [▶] of G-EQ.

L/R: Different adjustment values can be set for the left and right channels.

L+R: Sets the same adjustment values for the left and right channels.

When parametric EQ is adjusted, this setting will be turned off.

6 Touch [>>] of G-EQ.
The G-EQ list screen appears.

7 Touch [>>] of the desired speaker (channel).
The G-EQ adjustment screen appears.

8 Adjust the G-EQ to your preference.

Adjusting the Level

Touch [◀] or [▶] of the desired frequency to adjust the level.

9 Touch [RETURN] to return to the previous screen.

- When the speaker is set to the “OFF” mode, the graphic equalizer for that speaker cannot be set. Refer to “Setting the Speakers” (page 42).
- Check the playable frequency ranges of the connected speakers before making the equalizer adjustments. If the speaker’s playable frequency range is 55 Hz to 30 kHz, for example, adjusting the 40 Hz or 20 Hz band has no effect. Additionally, you may overload and damage the speakers.
- When graphic EQ is adjusted, the adjustment for parametric EQ becomes ineffective.

Parametric Equalizer Adjustments

The frequency bands of the graphic equalizer are fixed. This makes it very difficult to correct for undesired peaks and dips at specific frequencies. The parametric equalizer’s centre frequency can be tuned to these specific frequencies. Then, the bandwidth (Q) and level are fine-tuned, independently, to make the necessary corrections. The parametric equalizer function is an advanced tool for serious audiophiles.

1 Check that Defeat mode is off.

2 Touch [SETUP] on the main source screen.

The SETUP selection screen appears.

3 Touch [AUDIO].

The AUDIO SETUP screen will appear.

4 Touch [➤] of A.PROC.

The A.PROCESSOR list screen appears.

5 Select L/R or L+R by touching [◀] or [▶] of P-EQ.

L/R: Different adjustment values can be set for the left and right channels.

L+R: Sets the same adjustment values for the left and right channels.

When graphic EQ is adjusted, this setting will be turned off.

6 Touch [➤] of P-EQ.

The P-EQ list screen appears.

7 Touch [➤] of the desired speaker (channel).

The P-EQ adjustment screen appears.

8 Adjust the P-EQ to your preference.

Selecting the Band

Touch [◀] or [▶] of BAND to select the desired band.

Adjusting the Frequency

Touch [◀] or [▶] of FREQ. to adjust the frequency of the selected band.

Adjusting the Level

Touch [◀] or [▶] of LEVEL to adjust the level of the selected band.

Setting the Bandwidth

Touch [◀] or [▶] of Q. to select the bandwidth.

9 Touch [RETURN] to return to the previous screen.

- When the speaker is set to the “OFF” mode, the parametric equalizer for that speaker cannot be set. Refer to “Setting the Speakers” (page 42).
- It is not possible to adjust the frequencies of adjacent bands within 7 steps.
- Check the playable frequency ranges of the connected speakers before making the equalizer adjustments. If the speaker’s playable frequency range is 55 Hz to 30 kHz, for example, adjusting the 40 Hz or 20 Hz band has no effect. Additionally, you may overload and damage the speakers.
- When the parametric EQ is adjusted, the adjustment for graphic EQ becomes ineffective.

Setting Bass Sound Control

- 1 Check that Defeat mode is off (page 26).**
- 2 Touch [SETUP] on the main source screen.**
The SETUP selection screen is displayed.
- 3 Touch [AUDIO].**
The AUDIO SETUP screen appears.
- 4 Touch [>>] of A.PROC.**
The A.PROCESSOR list is displayed.
- 5 Touch [>>] of BASS SOUND CONT.**
The BASS SOUND CONT screen appears.

Setting Bass Compressor

You can adjust the sound of low frequencies as desired.

- 6 Touch [◀] or [▶] of BASS COMP. to select the desired mode.**
Bass sound is emphasized more as the mode is sequentially switched as MODE 1 → 2 → 3, offering you vivid low frequencies.
Select OFF when the setting is not necessary.
Touch [RETURN] to return to the previous screen.

Setting Bass Focus

Using the previously specified delay number (time difference) allows you to set a time difference between the front-rear/left-right speakers. Namely, it enables a time correction based on your preference. With an initial delay of 0.1 ms for each of the 0 to 200 steps, audible time correction can be achieved.

- 6 Set the delay number in the front and rear, and on the right and left of the desired speaker by touching the respective [◀] or [▶] button.**

- Any setting in Bass Focus is applied in time correction, too (pages 43-44).
- Touch [RETURN] to return to the previous screen.

Speaker Setup

The PXA-H700 or PXA-H701 can be set according to the playable frequency range of your speakers.

Check the playable frequency range of the speakers (not including the subwoofer) before performing this operation to verify whether the speakers can play low frequencies (of about 80 Hz or less).

- Avoid stopping, pausing, switching the disc, cueing, fast-forwarding or switching the audio channel of this unit while making this adjustment. The setting is cancelled if Decode mode is switched.

- 1 Check that Defeat mode is off.**
- 2 Touch [SETUP] on the main source screen.**
The SETUP selection screen appears.
- 3 Touch [AUDIO].**
The AUDIO SETUP screen will appear.
- 4 Touch [>>] of A.PROC.**
The A.PROCESSOR list screen appears.
- 5 Touch [>>] of SPEAKER SETUP.**
The adjusting screen of SPEAKER SETUP appears.
- 6 Select the speaker characteristic by touching [◀], [▶] of the desired speaker setting.**
OFF*¹: When no speaker is connected.
SMALL: When a speaker that cannot play low frequencies (80 Hz or less) is connected.
LARGE*²: When a speaker that can play low frequencies (80 Hz or less) is connected.

*¹ It is not possible to set the front speakers to "OFF".

*² If the front speakers are set to "SMALL", the rear and centre speakers cannot be set to "LARGE".

- The subwoofer can be set only to ON/OFF.
- If the centre speaker is turned "OFF", the centre channel's audio signals are added to the audio signals output from the front speakers.
- If you set the speaker response to "OFF", also set the speaker setting to "OFF" (page 42).
- Perform the setup for all the speakers ("Front", "Centre", "Rear" and "Subwoofer"). If not, the sound may not be balanced.
- When centre is set to "OFF", the setting is ineffective even if centre is set with this function.
- Through changing the settings on each speaker, a change in the output of the other speakers may occur due to the setting requirements.
- When using the PRO LOGIC II, if the rear speaker is set to "LARGE", then there will be no output from the subwoofer.

Setting of Dolby Digital

- 1 **Check that Defeat mode is off.**
- 2 **Touch [SETUP] on the main source screen.**
The SETUP selection screen appears.
- 3 **Touch [AUDIO].**
The AUDIO SETUP screen will appear.
- 4 **Touch [>>] of A.PROC.**
The A.PROCESSOR list screen appears.
- 5 **Touch [>>] of MULTI CH SETUP.**
The MULTI CH SETUP display appears.
Set the items below as you desire.

Adjusting the acoustic image (BI-PHANTOM)

In most installations, the centre speaker must be placed directly between the front passenger and driver. Using this function, the centre channel information is distributed to the left and right speakers. This creates an acoustic image simulating a centre speaker directly in front of each listener. Adjusting the centre width in PL II MUSIC (see "Using the Pro Logic II Mode," page 48), makes this function ineffective.

- *Avoid stopping, pausing, switching the disc, cueing, fast-forwarding or switching the audio channel of this unit while making this adjustment. The setting is cancelled if the Decode mode is switched.*

Touch [◀] or [▶] of BI-PHANTOM to adjust the level.
The level can be adjusted within the range of -5 to +5.
The higher the level, the more the position of the centre speaker is shifted to the sides.
The BI-PHANTOM function is turned off by touching [OFF].

- *This adjustment is effective when the setting of the centre speaker to SMALL or LARGE in the speaker setup settings.*
- *This adjustment is ineffective when the speaker is set CENTER to OFF in "Setting the Speakers" (page 42).*

Mixing bass sound to the rear channel (REAR MIX)

This function mixes the front channel audio signals to the audio signals output from the rear speakers, improving the sound in the vehicle's rear seat.

- *Avoid stopping, pausing, switching the disc, cueing, fast-forwarding or switching the audio channel of this unit while making this adjustment. The setting is cancelled if the Decode mode is switched.*

Touch [◀] or [▶] of REAR MIX to adjust the level.
The level can be adjusted in five steps: -6, -3, 0, +3 and +6. The higher the level, the more bass is output from the rear speakers. (The effect differs according to the software (DVD, etc.)
The REAR MIX function is turned off by touching [OFF].

- *This adjustment is ineffective when the rear speaker setup setting is set to "OFF".*
- *For linear PCM signals, the voice is output from the rear speaker regardless of the REAR FILL and REAR MIX setting.*

Achieving powerful high volume sound (LISTENING MODE)

With Dolby Digital, the dynamic range is compressed so that powerful sound can be achieved at regular volume levels. This compression can be cancelled to achieve an energetic sound with even greater power, like the sound in a movie theater.

This function works only in the Dolby Digital mode.

Touch [◀] or [▶] of LISTENING MODE to select STD or MAX.

STD: For powerful sound at regular volume levels

MAX.: For powerful sound at high volumes

- *Keep the volume to a level at which sounds outside the vehicle can still be heard.*

Adjusting the speaker levels (OUTPUT LEVEL)

The test tones help to make the volume adjustments of the different speakers. When levels are equal, a strong sense of presence can be heard from the different speakers at the listening position.

- *Avoid stopping, pausing, switching the disc, cueing, fast-forwarding or switching the audio channel of this unit while making this adjustment. The setting is cancelled if the decode mode is switched.*

- 1 Touch [ON] of OUTPUT LEVEL.

Test tone output is repeated for each of the different speaker channels. They will be repeated in the order shown below.

If no operation is performed for 2 seconds, the channel switches to the next channel.

Left → Centre → Right → Right Surround →
Left Surround → Left

- 2 While the test tone is being produced from the speakers, touch [◀] or [▶] of OUTPUT LEVEL balance the output from all the speakers.

- The adjustment range for the different speakers is -10 dB - +10 dB.
- Adjust based on the front speakers.

- 3 Touch [ON] again to turn off.

- *If a speaker is set to off mode, that speaker's level adjustment cannot be made. Refer to "Speaker Setup" (page 46).*

Adjusting the DVD Level

The volume (signal level) for Dolby Digital, Dolby PL II, DTS and PCM modes can be set.

- *Avoid stopping, pausing, switching the disc, cueing, fast-forwarding or switching the audio channel of this unit while making this adjustment. The setting is cancelled if the Decode mode is switched.*

- 1 Check that Defeat mode is off (page 26).**
- 2 Touch [SETUP] on the main source screen.**
The SETUP selection screen appears.
- 3 Touch [AUDIO].**
The AUDIO SETUP screen will appear.
- 4 Touch [>>] of A.PROC.**
The A.PROCESSOR list screen appears.
- 5 Touch [>>] of DVD LEVEL.**
The DVD LEVEL list screen appears.
- 6 Adjust the level by touching [<] or [>] of the desired adjusting mode.**
The level can be adjusted in the range of -5 dB to +5 dB.

Storing Settings in the Memory

Adjustment or setting contents can be stored.

Contents that can be stored vary depends on the audio processor used.

- 1 Check that Defeat mode is off.**
- 2 Touch [MEMORY] on the A.PROCESSOR list display.**
- 3 Within 5 seconds, touch any one of the preset buttons [P.SET 1] through [P.SET 6] on the A.PROCESSOR list screen.**

The setting contents are stored.

- *The stored contents will not be deleted even when the battery power cord is detached.*

Calling up the Preset Memory

- 1 Check that Defeat mode is off.**
- 2 Touch any one of the preset buttons [P.SET 1] through [P.SET 6] on the A.PROC list display to select the preset memory.**

- *It takes a few moments to call up the preset memory.*

Using the Pro Logic II Mode

Pro Logic processing can be conducted on the music signals recorded on two channels to achieve Dolby Pro Logic II surround sound. For two-channel Dolby Digital and DTS signals, there is also a "REAR FILL" function for outputting the signals of the front channel to the rear channel.

- 1 Check that Defeat mode is off.**
- 2 Touch [SETUP] on the main source screen.**
The SETUP selection screen appears.
- 3 Touch [AUDIO].**
The AUDIO SETUP screen will appear.
- 4 Touch [>>] of A.PROC.**
The A.PROCESSOR list screen appears.
- 5 Touch [>>] of DOLBY PLII/REAR FILL.**
The DOLBY PLII/REAR adjusting screen appears.
- 6 Touch [<] or [>] of DOLBY PLII/REAR to select the desired mode.**

PL II MOVIE: Suits the stereo TV shows and all programmes encoded in Dolby Surround. It improves the sound field directivity to near that of discrete 5.1-channel sound.

PL II MUSIC: Can be used for all stereo music recordings, and provides a wide, deep sound field.

OFF: Turns DOLBY PL II function to OFF.

If PL II MUSIC is selected, the centre width can be adjusted with following operations.

This function offers the optimum vocal position by adjusting the centre channel position between the centre speaker and the L/R speaker. (The adjustments established in "Adjusting the acoustic image (BI-PHANTOM)" (page 47) are ineffective while this function is activated.)

Touch [<] or [>] of CENTER WIDTH CONT to adjust the level.

The level can be adjusted between ± 0 to +7. When the level increases, the centre channel position moves from the centre speaker position to both sides.

Touch [OFF] of CENTER WIDTH CONT to turn off the centre width control.

- This adjustment is effective when the setting of the centre speaker is *SMALL* or *LARGE* in the speaker setup settings.
- “*REAR FILL*” function:
Depending on the input signals, the sound may only be output from the front speakers. In this case, the “*REAR FILL*” function can be used to output signals from the rear speakers as well.
- Avoid stopping, pausing, switching the disc, cueing, fast-forwarding or switching the audio channel of this unit while making this adjustment. The setting is cancelled if the Decode mode is switched.
- This adjustment is ineffective when the speaker is set *CENTER* to *OFF* in “*Setting the Speakers*” (page 42).
- This function only works with two-channel signals. This operation is ineffective when 5.1-channel DTS or Dolby Digital signals are input.
- If the setting of *REAR FILL* is made when *REAR MIX* is *ON*, sound is unchanged in the rear fill setting because *REAR MIX* is given priority during 2 channel decoder other than linear PCM.
- For linear PCM signals, the voice is output from the rear speaker regardless of the *REAR FILL* and *REAR MIX* setting.
- Touching [*RETURN*] will return to the previous screen.

Linear PCM Setting

The output when playing discs recorded in linear PCM can be set to 2 or 3 channels.

- 1 Check that Defeat mode is off.**
 - 2 Touch [*SETUP*] on the main source screen.**
The *SETUP* selection screen appears.
 - 3 Touch [*AUDIO*].**
The *AUDIO SETUP* screen will appear.
 - 4 Touch [*>>*] of *A.PROC.***
The *A.PROCESSOR* list screen appears.
 - 5 Touch [*◀*] or [*▶*] of *PCM MODE* to select 2 CH or 3 CH.**
2 CH: 2 ch output (L/R)
3 CH: 3 ch output (L/R/CENTER)
- This adjustment is ineffective when the speaker is set *CENTER* to *OFF* in “*Setting the Speakers*” (page 42).

Navigation System (Optional)

Switching the Navigation Screen (Optional)

If an optional Alpine Navigation System is connected to the IVA-W205R/IVA-W202R, the Navigation screen can be displayed on this unit.

- 1 Touch [*SOURCE*] on the main source screen.**
The source screen appears on the display.
 - 2 Touch [*NAV.*].**
The Navigation screen is displayed.
The operation is possible with the supplied navigation remote control.
For navigation operation, refer to the Owner’s Manual of the Navigation.
- Use the “*Setting the VISUAL Soft Button*” function (page 37), to select “*Nav.*”. The navigation mode becomes directly activated using the *VISUAL Soft Button*.
 - If the Navigation mode menu is not displayed on the main menu screen, set *NAV. IN* to *ON* in “*Setting the Navigation Mode*” (page 36).
 - When the Navigation System is on, the audio and visual navigation cuts in.

Portable Navigation System Operation (Optional)

An optional Alpine Portable Navigation System is controllable from the unit. For details on operation, refer to the Owner’s Manual of the Portable Navigation.

An external navigation system and portable navigation cannot be connected at the same time.

If the Built-in Dock is used for IVA-W205R

About dockable BLACKBIRD series or Portable Navigation devices with this unit:

- Docking to the *PMD-B100* is not possible.
 - For information on docking a portable navigation to the unit, consult your Alpine dealer.
- 1 Press \triangle on the unit.**
The unit changes to the *EJECT/TILT* screen.
 - 2 Touch [*OPEN*].**
The movable monitor will open.

- 3 Remove the slot panel, then insert the Portable Navigation device in the unit (See the illustration below).

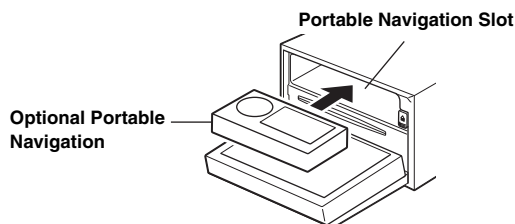

- The slot panel can be detached by placing a finger in the hole in the centre of the panel and pulling it down.
- If the face plate is attached, first remove the face plate, then the slot panel. After removing the slot panel, reattach the face plate.

- 4 After inserting, touch **[CLOSE]** on the EJECT/TILT screen.

The movable monitor will close.

- 5 Press **SOURCE**.

The SOURCE selection screen is displayed.

- 6 When the source name of **[BLACKBIRD]** on the SOURCE selection screen is displayed, touch the desired source name.

- For details on operation, refer to the Owner's Manual of the Portable Navigation device.

Removing the Portable Navigation Device

- 1 Press **▲** on the unit.
The display changes to the EJECT/TILT screen.
- 2 Touch **[OPEN]** or **[▲]** of **BLACKBIRD** on the EJECT/TILT screen.
The movable monitor will open.
- 3 Press **[▲]** behind the monitor.
The Portable Navigation device is removed.

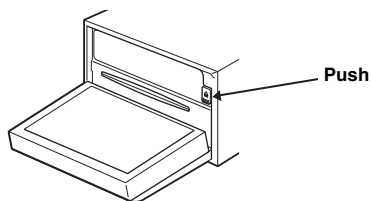

If an Optional Docking Station is used for IVA-W205R

- 1 Select the **BLACKBIRD** in "Setting the AUX Mode" (page 36).
- 2 Mount the Portable Navigation device to the optional docking station.
The connection to the Portable Navigation device is recognized in steps 1 and 2.
- 3 Press **SOURCE**.
The SOURCE selection screen is displayed.
- 4 Touch **[BLACKBIRD]**.
For details on operation, refer to the Owner's Manual of the Portable Navigation device.

Auxiliary Device (Optional)

Operating Auxiliary Devices (Optional)

To operate your devices connected to the AUX terminals on the rear panel of IVA-W205R/IVA-W202R, follow the procedure described below.

! WARNING

It is dangerous for the driver to watch the TV/Video while driving the vehicle. The driver may be distracted from looking ahead and an accident could occur.

Install the IVA-W205R/IVA-W202R correctly so that the driver cannot watch TV/Video unless the vehicle is stopped and the emergency brake is applied.

If the IVA-W205R/IVA-W202R is not installed correctly, the driver will be able to watch the TV/Video while driving the vehicle and may be distracted from looking ahead and cause an accident. The driver or other people could be severely injured.

- If you try to activate the auxiliary device while driving, the display will show the warning-**PICTURE OFF FOR YOUR SAFETY**.

- 1 Touch **[SOURCE]** on the main source screen.
The source screen appears on the display.

- 2 Touch **[AUX]***.
The external input screen is displayed.

- 3 Touch **[NTSC/PAL]** to change the video input.

- * The name which is given as the source name in "Setting the AUX Mode" on page 36 is displayed.
- If the AUX mode is not displayed on the main menu, set AUX IN to ON by following "Setting the AUX Mode" (page 36).
- The setting of switching NTSC/PAL, which you have set in this section, can be used in same way in "Switching the Visual Input Signal System" on page 36.
- The display mode changes by touching **[WIDE]**.
For operation, refer to "Switching Display Modes" on page 28.
- After connecting the KCA-410C, its AUX input can be used only in INTERRUPT MODE. For details, refer to the KCA-410C Owner's Manual.

TUE-T200DVB Operation (Optional)

Operating the TUE-T200DVB (Optional)

Operable when optional TUE-T200DVB is connected.
When DVB-T is selected in "Setting the AUX Mode" (page 36), the source is displayed in SOURCE selection screen.

- 1 While your vehicle is parked, touch [SOURCE] on the main source screen.**
The source screen appears on the display.
- 2 Touch [DVB-T].**
The DVB-T screen is displayed.
- 3 Perform the desired operation.**

Channel Number Up/Down or Favorite Channel Number Up/Down

- 1 Touch [TUNE] to select changing the Channel or the Favorite Channel.**
Touch [◀ CH] or [CH ▶] to move the Channel number Up/Down.
Touch [◀ FAV] or [FAV ▶] to move the Favorite Channel number Up/Down.

Calling up Main Menu Screen

- 1 Touch [MENU] to call up the main menu screen.**

Calling up Menu Operation Mode

- 1 Touch [MENU CONT] to call up the menu operation mode.**

Switching the Source

- 1 Touch [BAND].**
The source switches with each touch.

Calling up Electronic Programme Guide (EPG)

- 1 Touch [EPG] to call up the Electronic Programme Guide.**

Scanning Mode

- 1 Touch [P1/2].**
The function guide appears.
 - 2 Touch [A.MEMO] to start the auto scan procedure.**
- For detail, refer to the Owner's Manual of the TUE-T200DVB sold separately.

Changer (Optional)

Controlling CD Changer (Optional)

An optional 6-disc or 12-disc CD Changer may be connected to the IVA-W205R/IVA-W202R if it is Ai-NET compatible. With a CD Changer connected to the Ai-NET input of the IVA-W205R/IVA-W202R, the CD Changer will be controllable from the IVA-W205R/IVA-W202R.

If you connect a changer compatible with MP3, you can play CD-ROMs, CD-Rs, and CD-RWs containing MP3 files on the IVA-W205R/IVA-W202R.

Using the KCA-410C (Versatile Link Terminal) multiple changers can be controlled by the IVA-W205R/IVA-W202R.

See the Multi-Changer Selection section for selecting the CD Changers (explained on page 52).

- 1 Touch [SOURCE] on the main source screen.**
- 2 Touch [CD CHG.].**
The display changes to the CD changer mode screen.

When a 6 Disc CD Changer is connected;

- 1 Touch [P1/2]*.**
The Function Guide display appears.

* When an MP3 compatible CD changer or DVD changer is connected, touch repeatedly until the disc number is displayed.

- 2 Touch any one of the select buttons [DISC 1] through [DISC 6].**
DISC 1 through DISC 6 select the discs from the first disc to 6th disc.

When an MP3 compatible CD changer is connected;

- 1 Touch [P1/3] twice to change the Function Guide display.**
- 2 Touch any one of the select buttons [DISC 1] through [DISC 6].**
DISC 1 through DISC 6 select the discs from the first disc to 6th disc.

When a 12-Disc CD Changer is connected;

- You can select the disc numbers 1 to 6 in the same manner as for 6-disc Changer.
Touch [P1/3] twice to select disc numbers 7 to 12.
The function guide display changes so that DISC 7 through DISC 12 represent disc numbers 7 to 12.

- After selecting the desired disc, you can operate in the same way as for the CD player. For details, see the CD/MP3/WMA section.
- When an MP3 compatible CD changer is connected, the unit can play discs containing both audio data and MP3 data.
- The DVD changer (optional) is controllable from the IVA-W205R/IVA-W202R as well as the CD changer.

Multi-Changer Selection (Optional)

When using KCA-410C (Versatile Link Terminal), you can connect two changers.

1 In changer mode, touch **[CHG SEL]** to select the next changer (connected CD changers or KCA-420i).

2 To operate the selected changer, see “CD/MP3/WMA” section.

- To operate the selected changer, see “CD/MP3/WMA” (pages 15-17).

USB Operation (Optional)

Controlling USB (Optional)

If the optional USB Adapter for the MP3 (KCA-620M) is connected, it is controllable from the unit.

1 Touch **[SOURCE]** on the main screen.

2 Touch **[USB]**.

The display changes to the USB mode screen.

- After selecting the USB mode, you can operate in the same way as for the changer. For details, see the “Changer” and “CD/MP3/WMA” Section.

iPod® (Optional)

An iPod® can be connected to the IVA-W205R/IVA-W202R by using the FULL SPEED™ Connection Cable (sold separately). When the IVA-W205R/IVA-W202R is connected by using the cable, the controls on the iPod are not functional.

About iPod usable with this unit

The unit can be used with the fourth generation and above iPod, iPod photo, iPod mini or iPod nano. iPod Shuffle cannot be used, however.

- Touch wheel or scroll wheel type iPods without the dock connector cannot be connected to the unit.
- The unit can be used with the following iPod versions. Correct function of earlier versions cannot be guaranteed.

Fourth generation iPod: Ver 3.1.1

Fifth generation iPod: Ver 1.1.2

iPod photo: Ver.1.2.1

iPod mini: Ver. 1.4.1

iPod nano: Ver. 1.2

- The unit cannot be used with the software versions earlier than "2006-06-28". For details about "iPod Software Update," refer to the iPod Instruction Manual.

Playback

1 Touch [SOURCE] on the main source screen.

The SOURCE selection screen is displayed.

2 Touch [iPod].

The display shows the iPod mode screen.

3 Touch [◀◀] or [▶▶] to select the desired song.

Return to the beginning of the current song:

Touch [◀◀].

Fast backward:

Touch and hold [◀◀].

Advance to the beginning of the next song:

Touch [▶▶].

Fast forward:

Touch and hold [▶▶].

4 To pause playback, touch [▶ / ||].

Touching [▶ / ||] again will resume playback.

- If a song is playing on the iPod when it is connected to the IVA-W205R/IVA-W202R, it will continue playing after the connection.
- If the artist, album or song name, created in iTunes, has too many characters, songs may not be played back when connected to the IVA-W205R/IVA-W202R. Therefore, a maximum of 250 characters is recommended. The maximum number of characters for the head unit is 128 (128 byte).
- Some characters may not be correctly displayed.
- "NO SUPPORT" is displayed when text information is not compatible with the IVA-W205R/IVA-W202R.

Searching for a desired Song

An iPod can contain hundreds of songs. By keeping these songs organized in playlists, the IVA-W205R/IVA-W202R can use these to ease song searches.

Using the search mode's individual hierarchy, you can narrow down your search as shown in the table below.

Hierarchy 1	Hierarchy 2	Hierarchy 3	Hierarchy 4
Playlist	Song	—	—
Artist*	Album*	Song	—
Album*	Song	—	—
Song	—	—	—
Podcast	Episode	—	—
Genre*	Artist*	Album*	Song
Composer*	Album*	Song	—

For example: Searching by Artist name

The following example explains how an ARTIST search is performed. Another search mode can be used for the same operation, although the hierarchy differs.

Searching by artist name

1 Touch [🔍].

The search mode is activated, and the search list screen appears.

2 Touch [≫] of ARTIST.

The ARTIST search screen is displayed.

3 Select the desired artist.

To play back the artist directly

- 1 Touch [▶] next to the artist's name.
All songs of the selected artist are played back.

To search for the album of an artist

- 1 Touch [≫] of the selected artist.
The ALBUM search screen of the selected artist is displayed.
- 2 Touch [▶] next to the desired album's name.
All songs of the selected album are played back.

To search for a song in the album of an artist

- 1 Touch [≫] of the desired album in "To search for the album of an artist" in step 2.
The SONG search screen of the selected album is displayed.
- 2 Touch [▶] next to the desired song's name.
The selected song is played back.

- Touching [▶] of ALL will play back all songs in the list when you are in a hierarchy with an asterisk "*" (see table above).
- Touching [≫] of ALL will display the search list in the next hierarchy.
- In search mode, you can jump to an assigned position by touching the direct search bar for quick search. For details, refer to "Direct Search Function" (page 54).

Direct Search Function

The unit's direct search function can be used to search for an album, song, etc., more efficiently. In PLAYLIST/ARTIST/ALBUM/SONG/GENRE/COMPOSER/PODCAST mode, you can quickly target any song.

Example of ALBUM search screen

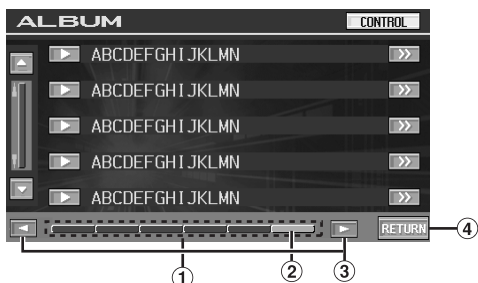

- ① Direct search bar
- ② Active point: The present selection position is displayed.
- ③ Touching [◀] or [▶] will move the active point by 1/6 each. Touching and holding [◀] or [▶] will move the active point continuously.
- ④ Returns to the previous screen.

1 In search mode, touch anywhere on the direct search bar, or touch and drag the active point to the desired place.

The active point moves to the specified place, and the search list will be changed according to the selected song position.

<SONG search example>

If there are 100 songs in your iPod, all the songs are allocated in the direct search bar.

Suppose the song you are searching for is located at around the 50th song of your library: touch around the middle (50%) of the direct search bar to jump to the song you desire.

Selecting Playlist/Artist/Album/Genre/Composer/Podcast

Playlist/Artist/Album/Genre/Composer/Podcast can be easily changed. For example, if you listen to a song from a selected album, the album can be changed.

1 Press [▼] or [▲] to select the desired Playlist/Artist/Album/Genre/Composer/Podcast.

- If the search selection mode is not activated, a SONG search is not possible.
- If an album is selected from an artist search, the album can be searched.
- During shuffle (M.I.X.) playback, this operation is not possible.

Random Play Shuffle (M.I.X.)

The Shuffle function of the iPod is displayed as M.I.X. on the IVA-W205R/IVA-W202R.

Shuffle ALL:

All songs in the iPod are played back in random sequence. If a song has been selected in the playlist/artist search mode before selecting Shuffle song, all songs in the iPod are played back randomly.

Shuffle Albums:

Select an album randomly in the iPod, and plays back the songs of the album in sequential order. If a song has been selected in the playlist/artist search mode before selecting Shuffle Album, only the albums within the playlist/artist are selected randomly. The songs of the album are played back sequentially.

Shuffle Songs:

When songs are selected in the Playlist, Artist, or Album, all songs of the Playlist, Artist, or Album are performed in random order.

1 Touch [ALL ∞].

The songs will be played back in random sequence.

M.I.X. SONGS ↔ (off)
(Shuffle Songs)

Touch [∞] after touching [P1/2].

→ M.I.X. ALBUMS → M.I.X. SONGS → (off)
(Shuffle Albums) (Shuffle Songs)

2 To cancel M.I.X. play, touch [ALL ∞] or [∞].

- For details of the search mode, refer to "Searching for a desired Song" (page 53).
- If a song is selected in the album search mode before selecting Shuffle (M.I.X.), the songs will not play back randomly even when Shuffle album is selected.

Repeat Play

Only Repeat One is available for the iPod.

Repeat One: A single song is repeatedly played back.

1 Touch [P1/2].

The function guide is displayed.

2 Touch [↺].

The file will be played repeatedly.

RPT ↔ (off)
(Repeat One) (Repeat the list being played back)

3 To cancel repeat play, touch [↺].

- During repeat playback, no other songs are selectable by touching [◀◀] or [▶▶].

Information

About DVDs

Music CDs and DVDs have grooves (tracks) in which the digital data is recorded. The data is represented as microscopic pits recorded into the track – these pits are read by a laser beam to play the disc. On DVDs, the density of the tracks and pits is twice that of CDs, so DVDs can contain more data in less space.

CDs

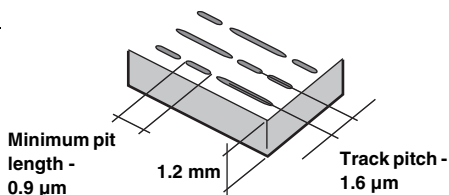

DVDs

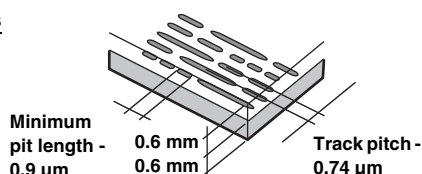

A 12 cm disc can contain one movie or about four hours of music.

In addition, DVDs provide sharp picture quality with vivid colours thanks to a horizontal resolution of over 500 lines (compared to less than 300 for VHS tape). With the addition of an optional, digital audio processor (PXA-H701, etc.), you can recreate the power and presence of a movie theater with Dolby Digital 5.1-channel Surround.

In addition, DVDs offer a variety of functions.

Multiple audio* (page 24)

Movies can be recorded in up to eight languages. The desired language can be selected from the unit.

Subtitles function* (page 25)

Movies can include subtitles in up to 32 languages. The desired subtitle language can be selected from the unit.

Multi angle function* (page 24)

When the DVD contains a movie shot from multiple angles, the desired angle can be selected from the unit.

Multi story function*

With this function, a single movie includes various story lines. You can select different story lines to view various versions of the same movie.

Operation differs from disc to disc. Story line selection screens including instructions appear during the movie. Just follow the instructions.

* These functions differ from disc to disc. For details, refer to the disc's instructions.

Terminology

Dolby Digital

Dolby Digital is a digital audio compression technology developed by Dolby Laboratories that allows large quantities of audio data to be efficiently recorded on discs. It is compatible with audio signals from mono (1 channel) all the way up to 5.1-channel surround sound. The signals for the different channels are completely independent, and since the sound is high quality digital there is no loss of sound quality.

* The separately sold digital audio processor (PXA-H701, etc.) is required to enjoy full 5.1-channel surround sound.

The IVA-W205R/IVA-W202R performs Dolby Digital decoding when it outputs analogue audio signals, it just happens to be 2-channel audio not 5.1-channel.

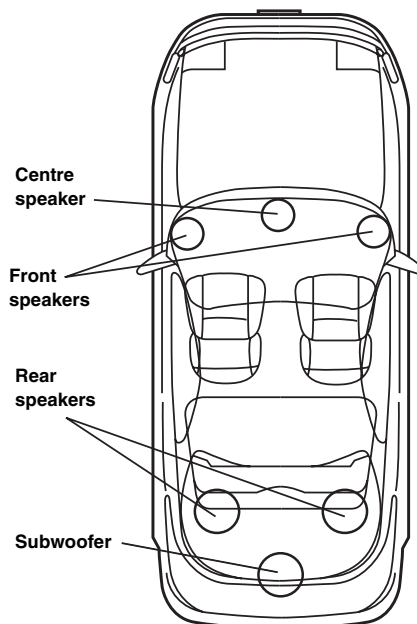

Speaker layout for enjoying Dolby Digital sound/DTS sound

DTS

This is a home-use digital sound format of the DTS Sound System. This is a high quality sound system, developed by DTS, Inc. for use in movie theatres.

DTS has six independent sound tracks. The theatre presentation is fully realised in the home and other settings. DTS is the abbreviation for Digital Theatre System.

* *To enjoy DTS surround sound you need the separately sold DTS digital audio processor (PXA-H701, etc.). The DVD video software must also have a DTS sound track.*

The IVA-W205R/IVA-W202R has a built-in DTS 2-channel audio decoder. Analogue audio outputs are available.

Dolby Pro Logic II

Dolby Pro Logic II plays 2-channel sources in 5 channels over the entire frequency range.

This is done with an advance, high sound quality matrix surround decoder which draws out the spatial properties of the original recording without adding any sounds to or changing the sound of the source.

* *The separately sold digital audio processor (PXA-H701, etc.) is required to enjoy Dolby Pro Logic II surround sound.*

Linear PCM audio (LPCM)

LPCM is a signal recording format used for music CDs.

Whereas music CDs are recorded at 44.1 kHz/16 bits, DVDs are recorded at 48 kHz/16 bits to 96 kHz/24 bits, thereby achieving higher sound quality than music CDs.

Rating levels (parental lock)

This is a function of the DVD for restricting the viewing age as stipulated by laws in different countries. The way in which viewing is restricted differs from DVD to DVD. Sometimes the DVD cannot be played at all, other times certain scenes are skipped, and other times certain scenes are replaced with other scenes.

List of Language Codes

(For details, see page 30.)

Abbreviation	Code	Language	Abbreviation	Code	Language	Abbreviation	Code	Language
AA	6565	Afar	IE	7369	Interlingue	RN	8278	Kirundi
AB	6566	Abkhazian	IK	7375	Inupiak	RO	8279	Romanian
AF	6570	Afrikaans	IN	7378	Indonesian	RU	8285	Russian
AM	6577	Amharic	IS	7383	Icelandic	RW	8287	Kinyarwanda
AR	6582	Arabic	IT	7384	Italian	SA	8365	Sanskrit
AS	6583	Assamese	IW	7387	Hebrew	SD	8368	Sindhi
AY	6589	Aymara	JA	7465	Japanese	SG	8371	Sangho
AZ	6590	Azerbaijani	JI	7473	Yiddish	SH	8372	Serbo-Croatian
BA	6665	Bashkir	JW	7487	Javanese	SI	8373	Singhalese
BE	6669	Byelorussian	KA	7565	Georgian	SK	8375	Slovak
BG	6671	Bulgarian	KK	7575	Kazakh	SL	8376	Slovenian
BH	6672	Bihari	KL	7576	Greenlandic	SM	8377	Samoan
BI	6673	Bislama	KM	7577	Cambodian	SN	8378	Shona
BN	6678	Bengali, Bangla	KN	7578	Kannada	SO	8379	Somali
BO	6679	Tibetan	KO	7579	Korean	SQ	8381	Albanian
BR	6682	Breton	KS	7583	Kashmiri	SR	8382	Serbian
CA	6765	Catalan	KU	7585	Kurdish	SS	8383	Siswati
CO	6779	Corsican	KY	7589	Kirghiz	ST	8384	Sesotho
CS	6783	Czech	LA	7665	Latin	SU	8385	Sundanese
CY	6789	Welsh	LN	7678	Lingala	SV	8386	Swedish
DA	6865	Danish	LO	7679	Laothian	SW	8387	Swahili
DE	6869	German	LT	7684	Lithuanian	TA	8465	Tamil
DZ	6890	Bhutani	LV	7686	Latvian, Lettish	TE	8469	Telugu
EL	6976	Greek	MG	7771	Malagasy	TG	8471	Tajik
EN	6978	English	MI	7773	Maori	TH	8472	Thai
EO	6979	Esperanto	MK	7775	Macedonian	TI	8473	Tigrinya
ES	6983	Spanish	ML	7776	Malayalam	TK	8475	Turkmen
ET	6984	Estonian	MN	7778	Mongolian	TL	8476	Tagalog
EU	6985	Basque	MO	7779	Moldavian	TN	8478	Setswana
FA	7065	Persian	MR	7782	Marathi	TO	8479	Tonga
FI	7073	Finnish	MS	7783	Malay	TR	8482	Turkish
FJ	7074	Fiji	MT	7784	Maltese	TS	8483	Tsonga
FO	7079	Faroese	MY	7789	Burmese	TT	8484	Tatar
FR	7082	French	NA	7865	Nauru	TW	8487	Twi
FY	7089	Frisian	NE	7869	Nepali	UK	8575	Ukrainian
GA	7165	Irish	NL	7876	Dutch	UR	8582	Urdu
GD	7168	Scots Gaelic	NO	7879	Norwegian	UZ	8590	Uzbek
GL	7176	Galician	OC	7967	Occitan	VI	8673	Vietnamese
GN	7178	Guarani	OM	7977	(Afan) Oromo	VO	8679	Volapuk
GU	7185	Gujarati	OR	7982	Oriya	WO	8779	Wolof
HA	7265	Hausa	PA	8065	Punjabi	XH	8872	Xhosa
HI	7273	Hindi	PL	8076	Polish	YO	8979	Yoruba
HR	7282	Croatian	PS	8083	Pashto, Pushto	ZH	9072	Chinese
HU	7285	Hungarian	PT	8084	Portuguese	ZU	9085	Zulu
HY	7289	Armenian	QU	8185	Quechua			
IA	7365	Interlingua	RM	8277	Rhaeto-Romance			

List of Country Codes

(For details, see page 30.)

Abbreviation	Code	Country	Abbreviation	Code	Country	Abbreviation	Code	Country
AD	6568	Andorra	DM	6877	Dominica	KI	7573	Kiribati
AE	6569	United Arab Emirates	DO	6879	Dominican Republic	KM	7577	Comoros
AF	6570	Afghanistan	DZ	6890	Algeria	KN	7578	Saint Kitts and Nevis
AG	6571	Antigua and Barbuda	EC	6967	Ecuador	KP	7580	Korea, Democratic People's Republic of
AI	6573	Anguilla	EE	6969	Estonia			
AL	6576	Albania	EG	6971	Egypt	KR	7582	Korea, Republic of
AM	6577	Armenia	EH	6972	Western Sahara	KW	7587	Kuwait
AN	6578	Netherlands Antilles	ER	6982	Eritrea	KY	7589	Cayman Islands
AO	6579	Angola	ES	6983	Spain	KZ	7590	Kazakhstan
AQ	6581	Antarctica	ET	6984	Ethiopia	LA	7665	Lao People's Democratic Republic
AR	6582	Argentina	FI	7073	Finland			
AS	6583	American Samoa	FJ	7074	Fiji	LB	7666	Lebanon
AT	6584	Austria	FK	7075	Falkland Islands	LC	7667	Saint Lucia
AU	6585	Australia	FM	7077	Micronesia, Federated States of	LI	7673	Liechtenstein
AW	6587	Aruba	FO	7079	Faroe Islands	LK	7675	Sri Lanka
AZ	6590	Azerbaijan	FR	7082	France	LR	7682	Liberia
BA	6665	Bosnia and Herzegovina	GA	7165	Gabon	LS	7683	Lesotho
BB	6666	Barbados	GB	7166	United Kingdom	LT	7684	Lithuania
BD	6668	Bangladesh	GD	7168	Grenada	LU	7685	Luxembourg
BE	6669	Belgium	GE	7169	Georgia	LV	7686	Latvia
BF	6670	Burkina Faso	GF	7170	French Guiana	LY	7689	Libyan Arab Jamahiriya
BG	6671	Bulgaria	GH	7172	Ghana	MA	7765	Morocco
BH	6672	Bahrain	GI	7173	Gibraltar	MC	7767	Monaco
BI	6673	Burundi	GL	7176	Greenland	MD	7768	Moldova, Republic of
BJ	6674	Benin	GM	7177	Gambia	MG	7771	Madagascar
BM	6677	Bermuda	GN	7178	Guinea	MH	7772	Marshall Islands
BN	6678	Brunei Darussalam	GP	7180	Guadeloupe	MK	7775	Macedonia, The former Yugoslav Republic of
BO	6679	Bolivia	GQ	7181	Equatorial Guinea			
BR	6682	Brazil	GR	7182	Greece	ML	7776	Mali
BS	6683	Bahamas	GS	7183	South Georgia and the South Sandwich Islands	MM	7777	Myanmar
BT	6684	Bhutan				MN	7778	Mongolia
BV	6686	Bouvet Island	GT	7184	Guatemala	MO	7779	Macau
BW	6687	Botswana	GU	7185	Guam	MP	7780	Northern Mariana Islands
BY	6689	Belarus	GW	7187	Guinea-Bissau	MQ	7781	Martinique
BZ	6690	Belize	GY	7189	Guyana	MR	7782	Mauritania
CA	6765	Canada	HK	7275	Hong Kong	MS	7783	Montserrat
CC	6767	Cocos (Keeling) Islands	HM	7277	Heard Island and McDonald Islands	MT	7784	Malta
CD	6768	Congo, the Democratic Republic of the				MU	7785	Mauritius
			HN	7278	Honduras	MV	7786	Maldives
CF	6770	Central African Republic	HR	7282	Croatia	MW	7787	Malawi
CG	6771	Congo	HT	7284	Haiti	MX	7788	Mexico
CH	6772	Switzerland	HU	7285	Hungary	MY	7789	Malaysia
CI	6773	Cote d'Ivoire	ID	7368	Indonesia	MZ	7790	Mozambique
CK	6775	Cook Islands	IE	7369	Ireland	NA	7865	Namibia
CL	6776	Chile	IL	7376	Israel	NC	7867	New Caledonia
CM	6777	Cameroon	IN	7378	India	NE	7869	Niger
CN	6778	China	IO	7379	British Indian Ocean Territory	NF	7870	Norfolk Island
CO	6779	Colombia	IQ	7381	Iraq	NG	7871	Nigeria
CR	6782	Costa Rica	IR	7382	Iran, Islamic Republic of	NI	7873	Nicaragua
CU	6785	Cuba	IS	7383	Iceland	NL	7876	Netherlands
CV	6786	Cape Verde	IT	7384	Italy	NO	7879	Norway
CX	6788	Christmas Island	JM	7477	Jamaica	NP	7880	Nepal
CY	6789	Cyprus	JO	7479	Jordan	NR	7882	Nauru
CZ	6790	Czech Republic	JP	7480	Japan	NU	7885	Niue
DE	6869	Germany	KE	7569	Kenya	NZ	7890	New Zealand
DJ	6874	Djibouti	KG	7571	Kyrgyzstan	OM	7977	Oman
DK	6875	Denmark	KH	7572	Cambodia	PA	8065	Panama

Abbreviation	Code	Country	Abbreviation	Code	Country	Abbreviation	Code	Country
PE	8069	Peru	SJ	8374	Svalbard and Jan Mayen	TW	8487	Taiwan, Province of China
PF	8070	French Polynesia	SK	8375	Slovakia	TZ	8490	Tanzania, United Republic of
PG	8071	Papua New Guinea	SL	8376	Sierra Leone	UA	8565	Ukraine
PH	8072	Philippines	SM	8377	San Marino	UG	8571	Uganda
PK	8075	Pakistan	SN	8378	Senegal	UM	8577	United States Minor Outlying Islands
PL	8076	Poland	SO	8379	Somalia	US	8583	United States
PM	8077	Saint Pierre and Miquelon	SR	8382	Suriname	UY	8589	Uruguay
PN	8078	Pitcairn	ST	8384	Sao Tome and Principe	UZ	8590	Uzbekistan
PR	8082	Puerto Rico	SV	8386	El Salvador	VA	8665	Holy See (Vatican City State)
PT	8084	Portugal	SY	8389	Syrian Arab Republic	VC	8667	Saint Vincent and the Grenadines
PW	8087	Palau	SZ	8390	Swaziland	VE	8669	Venezuela
PY	8089	Paraguay	TC	8467	Turks and Caicos Islands	VG	8671	Virgin Island, British
QA	8165	Qatar	TD	8468	Chad	VI	8673	Virgin Islands, U.S
RE	8269	Reunion	TF	8470	French Southern Territories	VN	8678	Viet Nam
RO	8279	Romania	TG	8471	Togo	VU	8685	Vanuatu
RU	8285	Russian Federation	TH	8472	Thailand	WF	8770	Wallis and Futuna
RW	8287	Rwanda	TJ	8474	Tajikistan	WS	8783	Samoa
SA	8365	Saudi Arabia	TK	8475	Tokelau	YE	8969	Yemen
SB	8366	Solomon Islands	TM	8477	Turkmenistan	YT	8984	Mayotte
SC	8367	Seychelles	TN	8478	Tunisia	YU	8985	Yugoslavia
SD	8368	Sudan	TO	8479	Tonga	ZA	9065	South Africa
SE	8369	Sweden	TP	8480	East Timor	ZM	9077	Zambia
SG	8371	Singapore	TR	8482	Turkey	ZW	9087	Zimbabwe
SH	8372	Saint Helena	TT	8484	Trinidad and Tobago			
SI	8373	Slovenia	TV	8486	Tuvalu			

In Case of Difficulty

If you encounter a problem, please turn the power off, then on again. If the unit is still not functioning normally, please review the items in the following checklist. This guide will help you isolate the problem if the unit is at fault. Otherwise, make sure the rest of your system is properly connected, or then consult your authorized Alpine dealer.

Basic

No function or display.

- Vehicle's ignition is off.
 - If connected according to the instructions, the unit will not operate with the vehicle's ignition off.
- Improper power lead connections.
 - Check power lead connections.
- Blown fuse.
 - Check the fuse on the battery lead of the unit; replace with the proper value if necessary.
- Internal micro-computer malfunctioned due to interference noise, etc.
 - Press the RESET switch with a ballpoint pen or other pointed article.
- Blackout mode is activated.
 - Cancel Blackout mode.

No sound or unnatural sound.

- Incorrect setting of volume/balance/fader controls.
 - Readjust the controls.
- Connections are not properly or securely made.
 - Check the connections and firmly connect.

Screen not displayed.

- Brightness control is set at the minimum position.
 - Adjust the Brightness control.
- Temperature in the vehicle is too low.
 - Increase the vehicle's interior temperature to operation temperature range.
- Connections to the DVD, CD player, navigation system are not securely made.
 - Check the connections and firmly connect.

Movement of displayed picture is abnormal.

- Temperature in the vehicle is too high.
 - Allow the vehicle's interior temperature to cool.

Unclear or noisy display.

- Fluorescent plate is worn out.
 - Replace the fluorescent plate.

Navigation system inoperative.

- Connections to the navigation system are incorrect.
 - Check the connections with the navigation system and connect the cables correctly and firmly.

The optional remote control is inoperative.

- The remote control sensor setting of "Rear Entertainment Function" is not set to this unit.
 - Set for this unit.

Unclear picture display.

- Fluorescent tube is exhausted.
 - Replace the fluorescent tube*.

* The fluorescent tube replacement is not free of charge even within the warranty period, for the tube is an article of consumption.

Radio

Unable to receive stations.

- No antenna, or open connection in the antenna cable.
 - Make sure the antenna is properly connected; replace the antenna or cable if necessary.

Unable to tune stations in the seek mode.

- You are in a weak signal area.
 - Make sure the tuner is in DX mode.
- If the area you are in is a primary signal area, the antenna may not be grounded and connected properly.
 - Check your antenna connections; make sure the antenna is properly grounded at its mounting location.
- The antenna may not be the proper length.
 - Make sure the antenna is fully extended; if broken, replace the antenna with a new one.

Broadcast is noisy.

- The antenna is not the proper length.
 - Extend the antenna fully; replace it if it is broken.
- The antenna is poorly grounded.
 - Make sure the antenna is grounded properly at its mounting location.
- The station signal is weak and noisy.
 - If above solution does not work, tune in another station.

CD/MP3/WMA/DVD/Video CD

Disc playback sound is wavering.

- Moisture condensation in the disc Module.
 - Allow enough time for the condensation to evaporate (about 1 hour).

Disc insertion not possible.

- A disc is already in the DVD player.
 - Eject the disc and remove it.
- The disc is being improperly inserted.
 - Make sure the disc is being inserted following the instructions in the CD/MP3/WMA, DVD/Video CD Player Operation section.

Unable to fast forward or backward the disc.

- The disc has been damaged.
 - Eject the disc and discard it; using a damaged disc in your unit can cause damage to the mechanism.

Disc playback sound skips due to vibration.

- Improper mounting of the unit.
 - Securely re-mount the unit.
- Disc is very dirty.
 - Clean the disc.
- Disc has scratches.
 - Change the disc.
- The pick-up lens is dirty.
 - Do not use a commercially available lens cleaner disc. Consult your nearest Alpine dealer.

Disc playback sound skips without vibration.

- Dirty or scratched disc.
 - Clean the disc; damaged disc should be replaced.

CD-R/CD-RW playback not possible.

- Close session (finalization) has not been performed.
 - Perform finalization and attempt playback again.

Error displays

- Mechanical error.
 - *Touch [▲] of DISC on the EJECT/TILT screen. After the error indication disappears, insert the disc again. If the above-mentioned solution does not solve the problem, consult your nearest Alpine dealer.

* IVA-W202R: Press [▲] on the front panel.

MP3/WMA is not played back.

- Writing error occurred. The CD format is not compatible.
 - Make sure the CD has been written in a supported format. Refer to "About MP3/WMA" (pages 16 and 17), then rewrite in the format supported by this device.

Unit does not operate.

- Monitor's power is not turned on.
 - Turn on the monitor's power.
- Condensation.
 - Wait a while (about 1 hour) for the condensation to dry.

No picture is produced.

- Monitor's mode is not switched to the mode you want to see.
 - Switch to the mode you want to see.
- Monitor's parking brake lead is not connected.
 - Connect the monitor's parking brake wire and set the parking brake.
(For details, refer to the monitor's instructions.)

Playback does not start.

- Disc is loaded upside-down.
 - Check the disc and load it with the labeled side facing upward.
- Disc is dirty.
 - Clean the disc.
- A disc not able to play back with this unit is loaded.
 - Check if the disc is able to be played back.
- Parental lock is set.
 - Cancel the parental lock or change the rating level.

Picture is unclear or noisy.

- Disc is being fast-forwarded or fast-reversed.
 - The picture may be slightly disturbed, but this is normal.
- Vehicle's battery power is weak.
 - Check the battery power and wiring.
(The unit may malfunction if the battery power is under 11 volts with a load applied.)
- Monitor's fluorescent tube is worn.
 - Replace the monitor's fluorescent tube.

Image stops sometimes.

- Disc is scratched.
 - Replaced with a non-scratched disc.

Indication for CD/MP3/WMA

HI-TEMP

- Protective circuit is activated due to high temperature.
 - The indicator will disappear when the temperature returns to within operation range.
 - Leave the power OFF until the temperature decreases and then turn the power ON again.

NO DISC

- No disc is inserted.
 - Insert a disc.
- Although a disc is inserted, "NO DISC" is displayed and the unit does not start to play or eject the disc.
 - Remove the disc by following these steps:
Press [▲] for at least 3 seconds.

LOADING ERROR

EJECT ERROR

- Mechanism error.
 - 1) *Touch [▲] of DISC on the EJECT/TILT screen and eject the disc.
If not ejecting, consult your Alpine dealer.

* IVA-W202R: Press [▲] on the front panel.
 - 2) When the error indication remains after ejecting, *touch [▲] of DISC on the EJECT/TILT screen again.
If the error indication still does not turn off after *touching [▲] of DISC on the EJECT/TILT screen for a few times, consult your Alpine dealer.

* IVA-W202R: Press [▲] on the front panel.
- Disc was forcibly pulled out by hand during Auto Loading.
 - When the error indication remains after loading, try to load again. If the error indication still does not turn off after pressing for a few times, consult your Alpine dealer.

DISC ERROR

- Scratched disc, contaminated disc/poor recording/disc incompatible with this unit.
 - *Touch [▲] of DISC on the EJECT/TILT screen.
 - Change the disc.

* IVA-W202R: Press [▲] on the front panel.

PROTECT

- A copy-protected WMA file was played back.
 - You can only play back non-copy-protected files.

UNSUPPORTED

- A sampling rate/bit rate not supported by the unit is used.
 - Use a sampling rate/bit rate that is supported by the unit.

Indication for DVD/Video CD

NO DISC

- No disc is inserted.
 - Insert a disc.
- Although a disc is inserted, "NO DISC" is displayed and the unit does not start to play or eject the disc.
 - Remove the disc by following these steps:
Press [▲] for at least 3 seconds.



- Head unit buttons and remote control (optional) operation are not possible.
 - For some discs or playing modes, certain operations are not possible. This is not a malfunction.

HI-TEMP

- Protective circuit is activated to high temperature.
 - The indicator will disappear when the temperature returns to within operation range.
 - Leave the power OFF until the temperature decreases and then turn the power ON again.

LOADING ERROR

EJECT ERROR

- Mechanism error.
 - 1) *Touch [▲] of DISC on the EJECT/TILT screen and eject the disc.
If not ejecting, consult your Alpine dealer.
 - 2) When the error indication remains after ejecting, *touch [▲] of DISC on the EJECT/TILT screen again.
If the error indication still does not turn off after *touching [▲] of DISC on the EJECT/TILT screen for a few times, consult your Alpine dealer.

* IVA-W202R: Press [▲] on the front panel.

DISC ERROR

- Scratched disc, contaminated disc/poor recording/disc incompatible with this unit.
 - *Touch [▲] of DISC on the EJECT/TILT screen.
 - Change the disc.

* IVA-W202R: Press [▲] on the front panel.

REGIONAL CODE VIOLATION

- Disc does not match regional code number.
 - Load a disc that matches the regional code number.

EJECT DISC BEFORE USING DVD-SETUP

- The DVD setup operation was attempted when a disc is inserted in the unit.
 - Eject the disc before the DVD setup operation.

Indication for CD changer

HI-TEMP

- Protective circuit is activated due to high temperature.
 - The indicator will disappear when the temperature returns to within operation range.

ERROR01

- Malfunction in the CD Changer.
 - Consult your Alpine dealer. Press the magazine eject button and pull out the magazine.
Check the indication. Insert the magazine again.
If the magazine cannot be pulled out, consult your Alpine dealer.
- Magazine ejection not possible.
 - Press the magazine eject button. If the magazine does not eject, consult your Alpine dealer.

ERROR02

- A disc is left inside the CD Changer.
 - Press the eject button to activate the eject function. When the CD Changer finishes the eject function, insert an empty CD magazine into the CD Changer to receive the disc left inside the CD Changer.

NO MAGAZINE

- No magazine is loaded into the CD Changer.
 - Insert a magazine.

NO DISC

- No indicated disc.
 - Choose another disc.

Indication for iPod Mode

NO iPod

- The iPod is not connected.
 - Make sure the iPod is correctly connected.
Make sure the cable is not bent excessively.
- The iPod's battery remains low.
 - Refer to the iPod's documentation and charge the battery.

NO SONG

- There are no songs in the iPod.
 - Download songs to the iPod and connect to the IVA-W205R/IVA-W202R.

ERROR01

- Communication error.
 - Turn the ignition key off, and then set to ON again.
 - Check the display by reconnecting between the iPod and the unit, using the iPod cable.

ERROR02

- Caused by the iPod Software Version not being compatible with this unit.
 - Update the iPod Software Version to be compatible with this unit.

Specifications

MONITOR SECTION

Screen Size	6.5"
LCD Type	Transparent type TN LCD
Operation System	TFT active matrix
Number of Picture Elements	280,800 pcs. (400 × 3 × 234)
Effective Number of Picture Elements	99% or more
Illumination System	Cold cathode fluorescent tube

FM TUNER SECTION

Tuning Range	87.5 – 108.0 MHz
Mono Usable Sensitivity	9.3 dBf (0.8 μV/75 ohms)
50 dB Quietening Sensitivity	13.5 dBf (1.3 μV/75 ohms)
Alternate Channel Selectivity	80 dB
Signal-to-Noise Ratio	80 dB
Stereo Separation	35 dB
Capture Ratio	2.0 dB

MW TUNER SECTION

Tuning Range	531 – 1,602 kHz
Usable Sensitivity	22.5 μV/27 dBf

LW TUNER SECTION

Tuning Range	153 – 281 kHz
Sensitivity (IEC Standard)	31.6 μV/30 dB

CD/DVD SECTION

Frequency Response	5 – 20,000 Hz
Wow & Flutter (% WRMS)	Below measurable limits
Total Harmonic Distortion	0.008% (at 1 kHz)
Dynamic Range	95 dB (at 1 kHz)
Channel Separation	85 dB (at 1 kHz)
Signal system	NTSC/PAL
Horizontal resolution	500 lines or greater
Video output level	1Vp-p (75 ohms)
Video S/N ratio	DVD: 60 dB
Audio S/N ratio	More than 105 dB

PICKUP

Wave length	DVD: 666 nm CD: 785 nm
Laser power	CLASS II

GENERAL

Power Requirement	14.4 V DC (11–16 V allowable)
Operating temperature	+32°F to +113°F (0°C to +45°C)
Maximum Power Output	50 W × 4
Output Voltage	2,000 mV/10k ohms
Bass	±14 dB at 60 Hz
Treble	±14 dB at 10 kHz
Weight	IVA-W205R:3.2 kg (7 lbs.) IVA-W202R:3.0 kg (6 lbs. 9 oz)
Audio output level	
Preout (Front, Rear):	2V/10k ohms (max.)
Preout (Subwoofer):	2V/10k ohms (max.)
AUX OUT:	1.2V/10k ohms
Ai-NET:	850 mV

CHASSIS SIZE (Monitor section)

Width	178 mm (7")
Height	100 mm (3-15/16")
Depth	165 mm (6-1/2")

- Due to continuous product improvement, specifications and design are subject to change without notice.
- The LCD panel is manufactured using an extremely high precision manufacturing technology. Its effective pixel ratio is over 99.99%. This means that there is a possibility that 0.01% of the pixels could be either always ON or OFF.

CAUTION



(Bottom side of Monitor player)

CAUTION-Laser radiation when open, DO NOT STARE INTO BEAM

(Bottom side of Monitor player)

Installation and Connections

Before installing or connecting the unit, please read the following and pages 4 to 6 of this manual thoroughly for proper use.

Warning

MAKE THE CORRECT CONNECTIONS.

Failure to make the proper connections may result in fire or product damage.

USE ONLY IN CARS WITH A 12 VOLT NEGATIVE GROUND.

(Check with your dealer if you are not sure.) Failure to do so may result in fire, etc.

BEFORE WIRING, DISCONNECT THE CABLE FROM THE NEGATIVE BATTERY TERMINAL.

Failure to do so may result in electric shock or injury due to electrical shorts.

DO NOT ALLOW CABLES TO BECOME ENTANGLED IN SURROUNDING OBJECTS.

Arrange wiring and cables in compliance with the manual to prevent obstructions when driving. Cables or wiring that obstruct or hang up on places such as the steering wheel, shift lever, brake pedals, etc. can be extremely hazardous.

DO NOT SPLICE INTO ELECTRICAL CABLES.

Never cut away cable insulation to supply power to other equipment. Doing so will exceed the current carrying capacity of the wire and result in fire or electric shock.

DO NOT DAMAGE PIPE OR WIRING WHEN DRILLING HOLES.

When drilling holes in the chassis for installation, take precautions so as not to contact, damage or obstruct pipes, fuel lines, tanks or electrical wiring. Failure to take such precautions may result in fire.

DO NOT USE BOLTS OR NUTS IN THE BRAKE OR STEERING SYSTEMS TO MAKE GROUND CONNECTIONS.

Bolts or nuts used for the brake or steering systems (or any other safety-related system), or tanks should NEVER be used for installations or ground connections. Using such parts could disable control of the vehicle and cause fire etc.

KEEP SMALL OBJECTS SUCH AS BOLTS OR SCREWS OUT OF THE REACH OF CHILDREN.

Swallowing them may result in serious injury. If swallowed, consult a physician immediately.

DO NOT INSTALL IN LOCATIONS WHICH MIGHT HINDER VEHICLE OPERATION, SUCH AS THE STEERING WHEEL OR SHIFT LEVER.

Doing so may obstruct forward vision or hamper movement etc. and results in serious accident.

Caution

HAVE THE WIRING AND INSTALLATION DONE BY EXPERTS.

The wiring and installation of this unit requires special technical skill and experience. To ensure safety, always contact the dealer where you purchased this product to have the work done.

USE SPECIFIED ACCESSORY PARTS AND INSTALL THEM SECURELY.

Be sure to use only the specified accessory parts. Use of other than designated parts may damage this unit internally or may not securely install the unit in place. This may cause parts to become loose resulting in hazards or product failure.

ARRANGE THE WIRING SO IT IS NOT CRIMPED OR PINCHED BY A SHARP METAL EDGE.

Route the cables and wiring away from moving parts (like the seat rails) or sharp or pointed edges. This will prevent crimping and damage to the wiring. If wiring passes through a hole in metal, use a rubber grommet to prevent the wire's insulation from being cut by the metal edge of the hole.

DO NOT INSTALL IN LOCATIONS WITH HIGH MOISTURE OR DUST.

Avoid installing the unit in locations with high incidence of moisture or dust. Moisture or dust that penetrates into this unit may result in product failure.

Precautions

- Be sure to disconnect the cable from the (-) battery post before installing your IVA-W205R/IVA-W202R. This will reduce any chance of damage to the unit in case of a short-circuit.
- Be sure to connect the colour coded leads according to the diagram. Incorrect connections may cause the unit to malfunction or damage to the vehicle's electrical system.
- When making connections to the vehicle's electrical system, be aware of the factory installed components (e.g. on-board computer). Do not tap into these leads to provide power for this unit. When connecting the IVA-W205R/IVA-W202R to the fuse box, make sure the fuse for the intended circuit of the IVA-W205R/IVA-W202R has the appropriate amperage. Failure to do so may result in damage to the unit and/or the vehicle. When in doubt, consult your Alpine dealer.
- The IVA-W205R/IVA-W202R uses female RCA-type jacks for connection to other units (e.g. amplifier) having RCA connectors. You may need an adaptor to connect other units. If so, please contact your authorized Alpine dealer for assistance.
- Be sure to connect the speaker (-) leads to the speaker (-) terminal. Never connect left and right channel speaker cables to each other or to the vehicle body.
- The Display must be completely retracted in the casing when installing. If it is not, problems may occur.
- When installing in automobiles, make sure the Display can open/close without coming in contact with the shift lever.

IMPORTANT

Please record the serial number of your unit in the space provided below and keep it as a permanent record. The serial number plate is located on the bottom of the unit.

SERIAL NUMBER: _____
INSTALLATION DATE: _____
INSTALLATION TECHNICIAN: _____
PLACE OF PURCHASE: _____

Installation

Caution

Do not block the unit's fan or heat sink, thus preventing air circulation. If blocked, heat will accumulate inside the unit and may cause a fire.

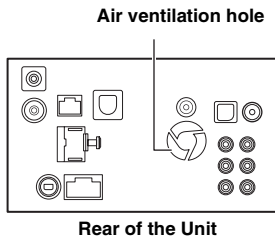

Caution concerning the installation location

- 1 Before installing, make sure that the opening and closing of the display will not interfere with operation of the shift lever.

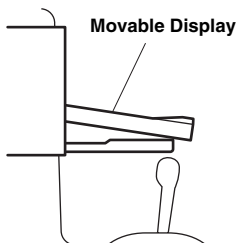

2 Angle of installation

Install at an angle of between horizontal and 30°. Note that installing at an angle outside of this range will result in a loss of performance and possibly damage.

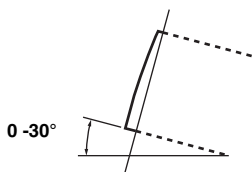

- 3 Remove the mounting sleeve from the main unit (see "Removal" on page 66).

The unit can be installed in the mounting sleeve in three positions by aligning its mounting holes (A to C) on the sides of the unit. Position A will be used in most cases. If B or C are to be used, the hole positions need to be modified.

First, determine the mounting position in the mounting sleeve, then affix the supplied seal (refer to "How to use a Seal" on page 66).

Slide the mounting sleeve into the dashboard and fix it with the metal shackles.

- If B or C is used, make sure that there is enough space depthwise before installing the unit. If the unit is forcibly pushed into the mounting sleeve, damage may occur.

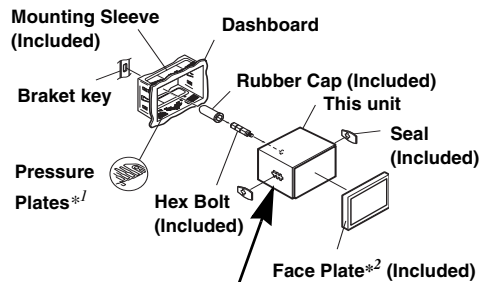

<Mounting Hole Position>

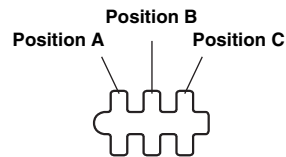

- Depending on the position chosen, the front panel will protrude differently.

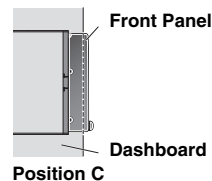
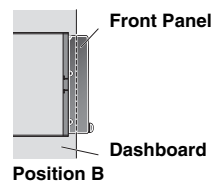
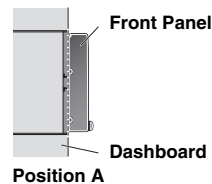

- *1 If the installed mounting sleeve is loose in the dashboard, the pressure plates may be bent slightly to remedy the problem.

How to use a Seal

If A is used for installation:

Affix the seal so that mounting holes B and C are covered.

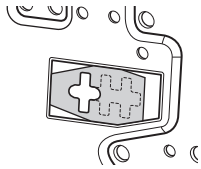

If B is used for installation:

Affix the seal so that mounting holes A and C are covered.

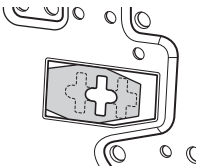

If C is used for installation:

Affix the seal so that the mounting holes A and B are covered.

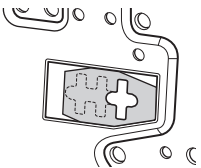

Installing the Face Plate

^{*2} If A is used, the face plate may be either 7 mm or 20 mm mounted.

If B is used, the face plate 20 mm must be modified before installing it.

To modify the face plate, consult your Alpine dealer.

If C is used, the face plate cannot be mounted. Consult your Alpine dealer.

4

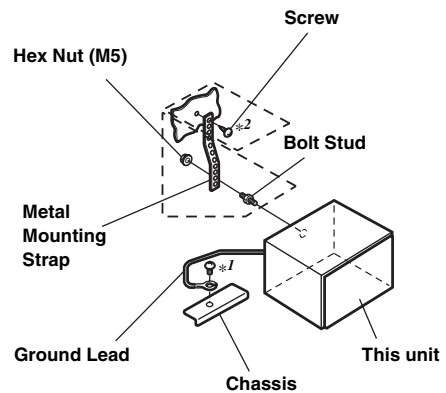

When your vehicle has the Bracket, mount the long hex bolt onto the rear panel of the IVA-W205R/IVA-W202R and put the Rubber Cap on the hex bolt. If your vehicle does not have the Mounting Support, reinforce the head unit with the metal mounting strap (not supplied). Secure the ground lead of the unit to a clean metal spot using a screw (*1) already attached to the vehicle's chassis. Connect all the leads of the IVA-W205R/IVA-W202R according to details described in the CONNECTION section.

- For the screw marked “*2”, use an appropriate screw for the chosen mounting location.

5 Slide the IVA-W205R/IVA-W202R into the dashboard until it clicks. This ensures that the unit is properly locked and will not accidentally come out from the dashboard.

Removal

1. Insert the bracket keys into the unit, along the guides on either side. The unit can now be removed from the mounting sleeve.

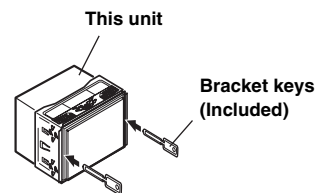

2. Pull the unit out, keeping it unlocked as you do so.

Connection Diagram of SPST Switch (Sold Separately)

(If the ACC power supply is not available)

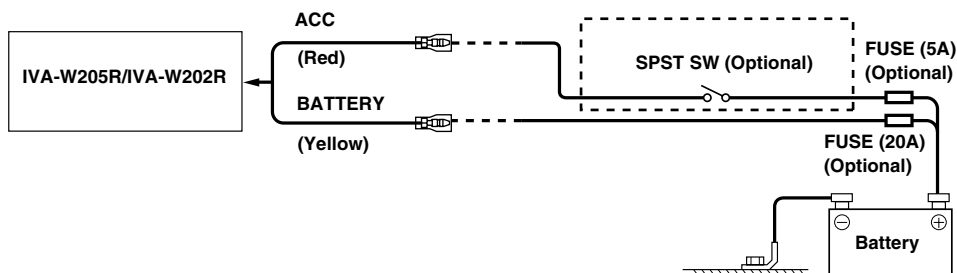

- If your vehicle has no ACC power supply, add an SPST (Single-Pole, Single-Throw) switch (sold separately) and fuse (Sold Separately).
- The diagram and the fuse amperage shown above are in the case when IVA-W205R/IVA-W202R is used individually.
- If the switched power (ignition) lead of the IVA-W205R/IVA-W202R is connected directly to the positive (+) post of the vehicle's battery, the IVA-W205R/IVA-W202R draws some current (several hundred milliamperes) even when its switch is placed in the OFF position and the battery may be discharged.

To prevent external noise from entering the audio system.

- Locate the unit and route the leads at least 10 cm away from the car harness.
- Keep the battery power leads as far away from other leads as possible.
- Connect the ground lead securely to a bare metal spot (remove any paint, dirt or grease if necessary) of the car chassis.
- If you add an optional noise suppressor, connect it as far away from the unit as possible. Your Alpine dealer carries various noise suppressors, contact them for further information.
- Your Alpine dealer knows best about noise prevention measures so consult your dealer for further information.

Connections

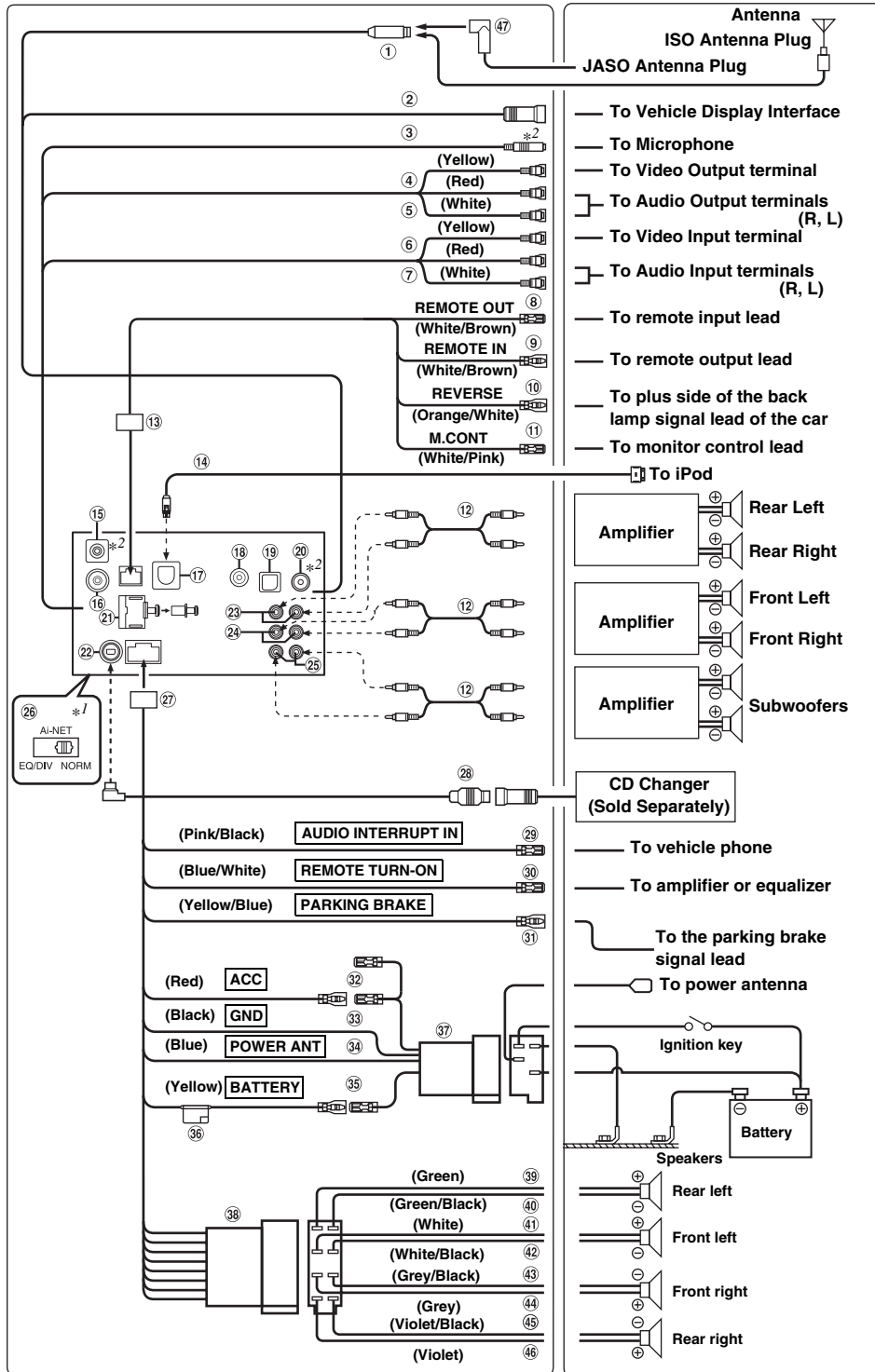

• Set the system switch to "NORM" when only a changer is connected (when the Ai-NET compatible equalizer is not used).

*1 The label is attached on the bottom of the unit.

*2 IVA-W205R only.

- ① **Antenna Receptacle**
- ② **Vehicle Display Interface Connector**
Outputs Vehicle Display Interface control signals. Connect this to the optional Vehicle Display Interface box. For details about connections, consult your nearest Alpine dealer.
- ③ **MIC Input Connector (IVA-W205R only)**
To Microphone (sold separately).
- ④ **Video Input Connector (AUX INPUT) (Yellow)**
Input the video.
- ⑤ **Audio Input Connectors (AUX INPUT)**
RED is right and WHITE is left input the audio.
- ⑥ **Video Output Connector (AUX OUTPUT) (Yellow)**
Output the video.
- ⑦ **Audio Output Connectors (AUX OUTPUT)**
RED is right and WHITE is left output the audio.
- ⑧ **Remote Control Output Lead (White/Brown)**
Connect this lead to the remote control input lead. This lead outputs the controlling signals from the remote control.
- ⑨ **Remote Control Input Lead (White/Brown)**
Connect the external Alpine product to the remote control output lead.
- ⑩ **Reverse Lead (Orange/White)**
Use only when a back-up camera is connected. Connect to the plus side of the car's reverse lamp that lights when the transmission is shifted into reverse (R). Switches the video picture to the back-up camera. This is linked with putting the car into reverse (R).
- ⑪ **Monitor Control Lead (White/Pink)**
Connect this to the Monitor Control Lead of the touch panel-compatible rear monitor.
- ⑫ **RCA Extension Cable (Sold Separately)**
- ⑬ **Remote IN/OUT Connector**
- ⑭ **FULL SPEED™ Connection Cable (KCE-422i) (sold separately)**
- ⑮ **GPS Antenna Receptacle (IVA-W205R only)**
To GPS Antenna (sold separately).
- ⑯ **Steering Remote Control Interface Connector**
To steering remote control interface box.
For details about connections, consult your nearest Alpine dealer.
- ⑰ **iPod Direct Connector**
iPod control signals.
Connect this to an iPod or to an optional Bluetooth Box using the FULL SPEED™ Connection Cable (KCE-422i) (sold separately).
To use a hands-free mobile phone, an optional Bluetooth Box connection is required. For details on connection, refer to the Owner's Manual of the Bluetooth Box.
- ⑱ **CAMERA Input Terminal**
Use when connecting a back-up camera.
- ⑲ **RGB Input Terminal**
Connect this to the RGB output terminal of the Navigation System.
- ⑳ **TMC Antenna Receptacle (IVA-W205R only)**
To TMC Antenna (sold separately).
- ㉑ **Digital Output Terminal (Optical)**
Use when combining fiber optic digital input compatible products.
- ㉒ **Ai-NET Connector**
Connect this to the output or input connector of another device (CD Changer, Equalizer, etc.) equipped with Ai-NET.
• *You can input TV/video sound by connecting an optional Ai-NET/RCA Interface cable (KCA-121B) to this component.*
- ㉓ **Rear Output RCA Connectors**
RED is right and WHITE is left.
- ㉔ **Front Output RCA Connectors**
RED is right and WHITE is left.
- ㉕ **Subwoofer RCA Connectors**
RED is right and WHITE is left.
- ㉖ **System Switch**
When connecting an equalizer or divider using Ai-NET feature, place this switch in the EQ/DIV position. When no device is connected, leave the switch in the NORM position.
• *Be sure to turn the power off to the unit before changing the switch position.*
- ㉗ **Power Supply Connector**
- ㉘ **Ai-NET Cable (Included with CD Changer)**
- ㉙ **Audio Interrupt In Lead (Pink/Black)**
- ㉚ **Remote Turn-On Lead (Blue/White)**
Connect this lead to the remote turn-on lead of your amplifier or signal processor.
- ㉛ **Parking Brake Lead (Yellow/Blue)**
Connect this lead to the power supply side of the parking brake switch to transmit the parking brake status signals to the IVA-W205R/IVA-W202R.
- ㉜ **Switched Power Lead (Ignition) (Red)**
Connect this lead to an open terminal on the vehicle's fuse box or another unused power source which provides (+) 12V only when the ignition is turned on or in the accessory position.
- ㉝ **Ground Lead (Black)**
Connect this lead to a good chassis ground on the vehicle. Make sure the connection is made to bare metal and is securely fastened using the sheet metal screw provided.
- ㉞ **Power Antenna Lead (Blue)**
Connect this lead to the +B terminal of your power antenna, if applicable.
• *This lead should be used only for controlling the vehicle's power antenna. Do not use this lead to turn on an amplifier or a signal processor, etc.*
- ㉟ **Battery Lead (Yellow)**
Connect this lead to the positive (+) post of the vehicle's battery.
- ㊱ **Fuse Holder (10A)**
- ㊲ **ISO Power Supply Connector**
- ㊳ **ISO Connector (Speaker Output)**
- ㊴ **Left Rear (+) Speaker Output Lead (Green)**
- ㊵ **Left Rear (-) Speaker Output Lead (Green/Black)**
- ㊶ **Left Front (+) Speaker Output Lead (White)**
- ㊷ **Left Front (-) Speaker Output Lead (White/Black)**
- ㊸ **Right Front (-) Speaker Output Lead (Grey/Black)**
- ㊹ **Right Front (+) Speaker Output Lead (Grey)**
- ㊺ **Right Rear (-) Speaker Output Lead (Violet/Black)**
- ㊻ **Right Rear (+) Speaker Output Lead (Violet)**
- ㊼ **ISO/JASO Antenna Adapter (Sold Separately)**
ISO/JASO Antenna Adaptor may be required, depending on the vehicle.

System Example

Connect the Ai-NET compatible audio processor (Fiber optic digital compatible), Navigation system, DVD player and changer.

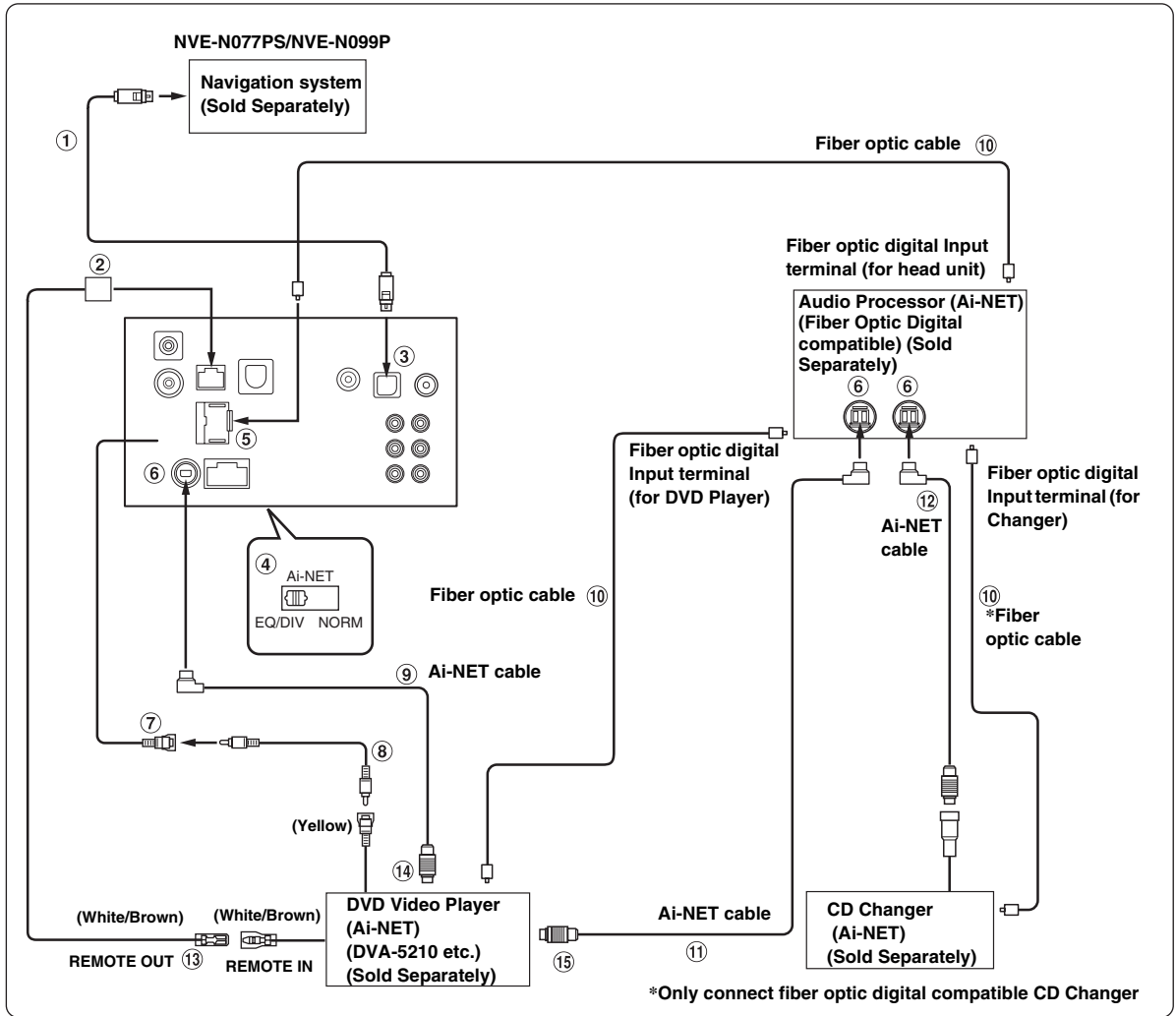

- When the fiber optic compatible product is connected, it is necessary to set the mode of this unit. Refer to "Setting the Digital Output" (page 37) and set to ON.
- When the NVE-N055PS is connected for the Navigation System, use the RGB conversion cable KCE-030N (Sold Separately).

Please observe the following when using Fiber Optic Cable.

- Do not coil the Fiber Optic Cable smaller than a 30 mm radius.
- Do not place anything on top of the Fiber Optic Cable.
- Be careful not to bend the Fiber Optic Cable at a sharp angle.

- ① **RGB Cable (Included with Navigation)**
- ② **Remote IN/OUT Connector**
- ③ **RGB Input Terminal**
Connect this to the RGB output terminal of the Navigation System.
- ④ **System Switch**
When connecting an equalizer or divider using Ai-NET feature, place this switch in the EQ/DIV position. When no device is connected, leave the switch in the NORM position.
 - *Be sure to turn the power off to the unit before changing the switch position.*
- ⑤ **Digital Output Terminal**
- ⑥ **Ai-NET Connector**
Connect this to the output or input connector of other product equipped with Ai-NET.
- ⑦ **Video Input Connector (AUX INPUT) (Yellow)**
Connect the video output lead of a DVD video player or DVD changer to this terminal.
- ⑧ **RCA Extension Cable (Included with DVD video player)**
- ⑨ **Ai-NET Cable (Included with DVD video player)**
- ⑩ **Fiber Optic Cable (Sold Separately)**
- ⑪ **Ai-NET Cable (Included with Audio Processor)**
- ⑫ **Ai-NET Cable (Included with CD Changer)**
- ⑬ **Remote Control Output Lead (White/Brown)**
Connect this lead to the remote control input lead. This lead outputs the controlling signals from the remote control.
- ⑭ **To Ai-NET Connector (Grey)**
- ⑮ **To Ai-NET Connector (Black)**

When Connecting External Equipment

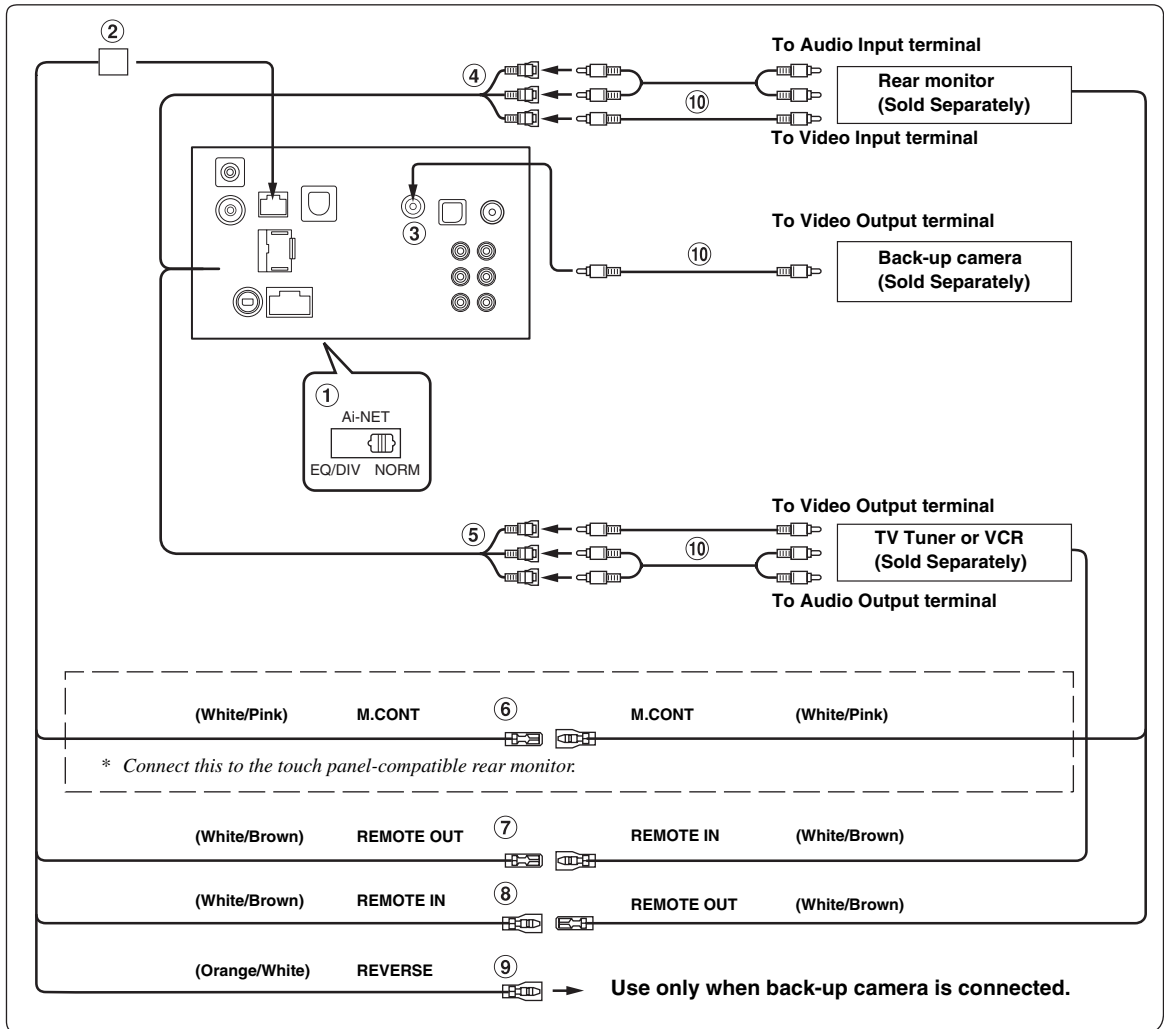

① System Switch

When connecting an equalizer or divider using Ai-NET feature, place this switch in the EQ/DIV position. When no device is connected, leave the switch in the NORM position.

- Be sure to turn the power off to the unit before changing the switch position.

② Remote IN/OUT Connector

③ CAMERA Input Terminal

Use when connecting a back-up camera.

④ Video/Audio Output Connectors (AUX OUTPUT)

Use when connecting an optional monitor etc.

⑤ Video/Audio Input Connectors (AUX INPUT)

⑥ Monitor Control Lead (White/Pink)

Connect this to the Monitor Control Lead of the touch panel-compatible rear monitor.

⑦ Remote Control Output Lead (White/Brown)

Connect this lead to the remote control input lead. This lead outputs the controlling signals from the remote control.

⑧ Remote Control Input Lead (White/Brown)

⑨ Reverse Lead (Orange/White)

Connect to the plus side of the car's reverse lamp which lights when the transmission is shifted into reverse (R). Switches the video picture to the back-up camera. This is linked to putting the car into reverse (R).

⑩ RCA Extension Cable (Sold Separately)



Car Audio and Navigation Systems

GERÄTE-PASS

AUDIO SYSTEME

Fahrzeugmarke: _____ Typ: _____

Amtl. Kennzeichen: _____

Name des Halters: _____

Straße: _____

Wohnort: _____

Bitte füllen Sie diesen Pass vollständig aus und bewahren Sie ihn außerhalb des Fahrzeugs auf:

Im Falle eines Diebstahls wird für Sie die Schadensabwicklung mit der Versicherung einfacher, und Sie erleichtern der Polizei die Fahndung nach den Tätern.

Appendix

Product Information Card

Produkt-Informationskarte

Carte d'informations sur le produit

Tarjeta de información del producto

English

Filling in this Product Information Card is voluntary. If you fill in this card and send it to Alpine, your data will be tabulated into reference data for future Alpine product development. In addition, in the future you may receive information about new products or Survey Mail requesting additional opinions about Alpine products or services. If you agree to the above term, please sign your name in the indicated space and return the card. Any additional comments or inquiries may be sent to : Person in charge of Customer Service department Alpine Electronics (Europe) GmbH.
Frankfurter Ring 117, 80807 München, Germany
Phone: +49-(0)89-32 42 640

Deutsch

Das Ausfüllen dieser Produktinformations-Karte ist freiwillig. Sollten Sie diese Karte vervollständigen, so werden die Daten für zukünftige Produktentwicklungen von Alpine als Referenzdaten herangezogen. Ebenso können Sie in der Zukunft Informationen über neue Alpine Produkte erhalten oder uns auch Ihre Meinung über Alpine Produkte und Dienstleistungen im Rahmen von Kunden-Befragungen mitteilen. Stimmen Sie dem Kontakt durch Alpine zu, so würden wir Sie bitten, in dem dafür vorgesehenen Feld zu unterschreiben und die Karte kostenfrei an uns zurückzuschicken. Zusätzliche Kommentare und Meinungen können Sie gerne an den zuständigen Kontakt im Kundendienst Alpine Electronics (Europe) GmbH senden.
Frankfurter Ring 117, 80807 München, Germany
Phone: 089-32 42 640

Français

En remplissant volontairement cette fiche, et en l'envoyant à Alpine, vous acceptez que ces informations soient utilisées par Alpine, dans le cadre de développement de nouveaux produits. Par ailleurs, vous autorisez Alpine à solliciter votre opinion par mailing sur de nouveaux produits ou services. Si vous acceptez les termes ci-dessus, veuillez signer cette carte à l'endroit indiqué, et nous la retourner. Tout autre commentaire ou demande doit être adressé à l'attention de: Responsable du service consommateur Alpine Electronics (Europe) GmbH.
Frankfurter Ring 117, 80807 München, Germany
Phone: +49-(0)89-32 42 640

Español

El envío de la información solicitada es voluntario. Si Vd. nos la remite, será utilizada de modo confidencial para el desarrollo de futuros productos Alpine. Si Vd. desea recibir información sobre nuevos productos de nuestra gama, indique su nombre en el espacio designado y remitános la tarjeta. Cualquier solicitud adicional puede ser enviada a : Persona responsable del Servicio de Atención al Cliente de Alpine Electronics (Europe) GmbH.
Frankfurter Ring 117, 80807 München, Germany
Phone: +49-(0)89-32 42 640

Q1. PRODUCT PURCHASED

1. Cassette Player
2. CD Player
3. MD Player
4. DVD Player
5. CD Changer
6. Amplifier
7. Speaker
8. Subwoofer
9. Monitor Controller
10. Video Monitor
11. Navigation
12. Processor/Equalizer
13. CD/Video CD Changer
14. Other _____

Q2. MODEL NUMBER: _____

Q3. DATE OF PURCHASE:

Month: _____ Year: _____

Q4. If navigation system, which monitor?

1. Alpine → (Model No.) _____
2. Other → (Brand Name) _____

Q5. STORE TYPE WHERE PURCHASED:

1. Car Audio Specialist
2. Audio/Video Store
3. Electronics/Appliance Store
4. Car Accessories Shop
5. Other _____

Q6. Type of vehicle in which this unit is installed:

Make: _____ Model: _____
Purchased _____ Model _____
Year: _____ Year: _____

Q7. How was this vehicle purchased?

1. Purchase
2. Lease

Q8. Purpose of buying this unit?

1. Addition
 2. Replacement
- ↓
- Previous brand replaced?
 - 1. Factory installed
 - 2. Alpine
 - 3. Other → (Brand Name) _____

Q9. Have you purchased Alpine products before?

1. First time
2. Two or More times

Q10. When you purchased this Alpine unit, did you compare it with other brand?

1. Yes → (Brand Name) _____
2. No

Q11. GENDER

1. Male
2. Female

Q12. AGE _____

Q13. MARITAL STATUS

1. Single
2. Married

Q14. OCCUPATION

1. Company Owner/Self-employed/Freelance
2. Manager
3. Company Employee
4. Civil Servant
5. Educator
6. Student
7. Other _____

Q15. Comments _____

Q1. gekauftes Gerät

1. Kassetten-Spieler
2. CD-Spieler
3. MD-Spieler
4. DVD-Spieler
5. CD-Wechsler
6. Verstärker
7. Lautsprecher
8. Subwoofer
9. Monitor-Controller
10. Video-Monitor
11. Navigationssystem
12. Prozessor/Equalizer
13. CD/Video-CD-Wechsler
14. andere _____

Q2. Modellnummer: _____

Q3. Kaufdatum:

Monat: _____ Jahr: _____

Q4. Falls Navigationssystem: Welcher Monitor?

1. Alpine → (Modellnr.) _____
2. Anderer Hersteller → (Herstellername) _____

Q5. Art des Geschäfts, in dem Sie das Gerät gekauft haben:

1. Spezialist für Auto-Audioanlagen
2. Audio-/Video-Geschäft
3. Elektro-/Geschäft
4. Autzubehör-Geschäft
5. Anderer Hersteller _____

Q6. Art des Fahrzeugs, in das das Gerät installiert wurde:

Marke: _____ Modell: _____
gekauft im _____
Jahr: _____ Baujahr: _____

Q7. Wie haben Sie das Fahrzeug gekauft?

1. Achat
2. Location-bail

Q8. Zweck des Kaufs dieses Geräts?

1. Zusätzlich
 2. Austausch
- ↓
- Marke des ausgetauschten Geräts?
 - 1. Serienmäßige Ausstattung
 - 2. Alpine
 - 3. Anderer Hersteller → (Herstellername) _____

Q9. War dies das erste Mal, dass Sie ein Alpine-Gerät gekauft haben?

1. Erstes Mal
2. Zweites Mal oder öfter

Q10. Haben Sie dieses Alpine-Gerät vor dem Kauf mit Geräten anderer Hersteller verglichen?

1. Ja → (Herstellername) _____
2. Nein

Q11. Geschlecht

1. Männlich
2. Weiblich

Q12. Alter _____

Q13. Familienstand

1. Ledig
2. Verheiratet

Q14. Beruf

1. Selbständige/Firmeninhaber/freiberuflich Tätige
2. Leitende Angestellte
3. Sonstige Angestellte
4. Beamte
5. Schulbildung
6. Studium
7. Sonstige _____

Q15. Kommentar: _____

Q1. PRODUIT ACHETE

1. Lecteur de cassette
2. Lecteur de CD
3. Lecteur MD
4. Lecteur DVD
5. Changeur de CD
6. Amplificateur
7. Haut-parleur
8. Haut-parleur de graves
9. Station Multimedia
10. Moniteur Vidéo
11. Navigation
12. Processeur/Equaliseur
13. Changeur de CD/CD Vidéo
14. Autre _____

Q2. NUMERO DU MODELE: _____

Q3. DATE D'ACHAT:

Mois: _____ Année: _____

Q4. Si c'est un système de navigation, quel moniteur?

1. Alpine → (N° du modèle) _____
2. Autre → (Marque) _____

Q5. TYPE DE MAGASIN OU VOUS AVEZ ACHETE LE PRODUIT:

1. Spécialiste autoradio
2. Magasin audio/vidéo
3. Magasin d'électronique/appareils
4. Magasin d'accessoires automobiles
5. Autre _____

Q6. Type de véhicule dans lequel cet appareil est installé:

Marque: _____ Modèle: _____
Année _____ Année du d'achat: _____ modèle: _____

Q7. Comment avez-vous acheté ce véhicule?

1. Achat
2. Location-bail

Q8. Pourquoi avez-vous acheté cet appareil?

1. Addition
 2. Remplacement
- ↓
- Marque précédente remplacée?
 - 1. Installée en usine
 - 2. Alpine
 - 3. Autre → (Marque) _____

Q9. Avez-vous déjà acheté des produits Alpine?

1. Première fois
2. Deux fois ou plus

Q10. Lorsque vous avez acheté ce produit Alpine, l'avez-vous comparé à une autre marque?

1. Oui → (Marque) _____
2. Non

Q11. SEXE

1. Masculin
2. Féminin

Q12. AGE _____

Q13. SITUATION DE FAMILLE

1. Célibataire
2. Marié

Q14. PROFESSION

1. Entrepreneur/Travailleur indépendant/Freelance
2. Directeur
3. Employé de bureau
4. Fonctionnaire
5. Educateur
6. Etudiant
7. Autre _____

Q15. Commentaires _____

Q1. Producto Comprado

1. Radio/Cassette
2. Radio/CD
3. Reproductor de MD
4. Reproductor de DVD
5. Cambiador de CD
6. Amplificador
7. Altavoz
8. Subwoofer
9. Monitor de control
10. Monitor de video
11. Sistema de navegación
12. Procesador/Equalizador
13. Cambiador de CD/Video CD
14. Otros _____

Q2. Número de modelo: _____

Q3. Fecha de compra:

Mes: _____ Año: _____

Q4. En caso de sistema de navegación, ¿qué monitor?

1. Alpine → (N° de modelo) _____
2. Otros → (Nombre de marca) _____

Q5. TIPO DE TIENDA DONDE COMPRÓ:

1. Especialista en audio de automóviles
2. Tienda de audio/video
3. Tienda de electrónica/electrodomésticos
4. Tienda de accesorios automovilísticos
5. Otros _____

Q6. Tipo de vehículo en que la unidad está instalada:

Marca: _____ Modelo: _____
Año de compra: _____ Año del modelo: _____

Q7. ¿Cómo fue comprado este vehículo?

1. compra
2. Leasing

Q8. ¿Propósito de comprar esta unidad?

1. Mejora del sistema
 2. Sustitución
- ↓
- ¿Sustitución de marca anterior?
 - 1. Instalado en la fábrica
 - 2. Alpine
 - 3. Otros → (Nombre de marca) _____

Q9. ¿Ha comprado Vd. productos Alpine anteriormente?

1. Primera vez
2. Dos o más veces

Q10. Cuando usted compró esta unidad Alpine, ¿la comparó con otros fabricantes?

1. Si → (Nombre de marca) _____
2. No

Q11. SEXO

1. Masculino
2. Femenino

Q12. Edad _____

Q13. Estado civil

1. Soltero
2. Casado

Q14. Ocupación

1. Propietario de empresa/Autónomo/ Profesional independiente
2. Gerente
3. Empleado de compañía
4. Empleado público
5. Profesor
6. Estudiante
7. Otros _____

Q15. Comentarios _____

Scheda informazioni prodotto

Italiano

La compilazione di questa formulario è volontaria. Se compilate questo formulario, ritornandolo ad Alpine, i Vostri dati saranno raccolti in un file di riferimento per lo sviluppo dei nuovi prodotti Alpine. In aggiunta Voi potrete ricevere in futuro informazioni riguardanti i nuovi prodotti o la richiesta di una Vostra opinione circa i prodotti o i servizi forniti da Alpine. Se siete d'accordo, Vi preghiamo di ritornarci il formulario completato negli appositi spazi con i Vostri dati. In caso desideriate fornire altri commenti o richiedere informazioni aggiuntive, potete indirizzare il tutto a : Responsabile dipartimento Servizio Clienti Alpine Electronics (Europe) GmbH.
Frankfurter Ring 117, 80807 München, Germany
Phone: +49-(0)89-32 42 640

Q1. PRODOTTO ACQUISTATO

1. Lettore di cassette
2. Lettore CD
3. Lettore MD
4. Lettore DVD
5. CD Changer
6. Amplificatore
7. Altoparlante
8. Subwoofer
9. Radio Monitor
10. Monitor video
11. Sistema di navigazione
12. Processore/equalizzatore
13. Cambia CD/Video CD
14. Altro _____

Q2. NUMERO MODELLO: _____

Q3. DATA DI ACQUISTO:

Mese: _____ Anno: _____

Q4. In caso di acquisto di un sistema di navigazione, quale monitor possiede?

1. Alpine → (No. Modello) _____
2. Altro → Nome marca _____

Q5. NEGOZIO DI ACQUISTO:

1. Specialista Car Stereo
2. Negozio di audio/video
3. Negozio di elettronica/elettrodomestici
4. Negozio accessori automobile
5. Altro _____

Q6. Tipo di veicolo posseduto:

Marca: _____ Modello: _____
Anno _____ Anno _____
acquisto: _____ modello: _____

Q7. Modalità acquisto

1. Acquisto
2. Leasing

Q8. Scopo acquisto

1. Aggiunta
2. Sostituzione

- ↓
- Marca sostituita
 - 1. Installato di fabbrica
 - 2. Alpine
 - 3. Altro → (Nome marca) _____

Q9. Avevate già acquistato prodotti Alpine?

1. No
2. Due o tre volte

Q10. Nell'acquistarlo, avete paragonato questo prodotto ad un'altra marca?

1. Sì → (Nome marca) _____
2. No

Q11. SESSO

1. Maschile
2. Femminile

Q12. ETÀ _____

Q13. STATO CIVILE

1. Celibe/nubile
2. Coniugato/coniugata

Q14. LAVORO

1. Proprietario di azienda/artigiano/libero professionista
2. Manager
3. Impiegato
4. Impiegato statale
5. Insegnante
6. Studente
7. Altro _____

Q15. Commenti _____

◆ I agree to the above stated terms of the Alpine Product Information Card.
◆ Ich stimme dem Kontakt durch Alpine für Informations- und Befragungszwecke zu.
◆ J'accepte les termes de cette carte d'information produit Alpine.
◆ Estoy conforme con los términos de la tarjeta de información sobre producto de Alpine.
◆ Accetto i termini della scheda informazioni prodotti Alpine.

_____ (Date/Datum/Date/Fecha/Data)

_____ (Signature/Unterschrift/Signature/Firma)

Name/Nom/Nombre/Nome

(First Name/Vorname/Prénom/Primer nombre/Nome)

(Surname/Familiennome/Nom de famille/Apellido/Cognome)

Home Address/Privatanschrift/Adresse/Dirección/Indirizzo

(Street/Straße/Rue/Calle/Via) (Post Code/Postleitzahl/Code postal/Código postal/Codice postale)

(Town/City/Stadt/Ville/Ciudad/Città) (Country/Land/Pays/Pais/Paese)

Telephone Number: _____

E-Mail/Correo electrónico: _____

Q1 NO. Other	Q2
Q3 Month Year	Q4 NO.1. Model No. NO.2. Brand Name
Q5 NO. Other	Q6 Make: Model: Purchased Year: Mode/Year:
Q7 NO.	Q8 NO. 1 Previous brand replaced. Brand Name 2 1. 2. 3.
Q9 NO.	Q10 1 Brand Name NO. 2 _____
Q11 NO.	Q12 years old
Q13 NO.	Q14 NO. Other
Q15 Comments _____ _____	

S/NO. LABEL

NE PAS AFFRANCHIR

NICHT FREIMACHEN
NO STAMP REQUIRED

REPOSE PAYEE/ WERBEANTWORT
ALLEMAGNE

ALPINE ELECTRONICS (EUROPE) GmbH
Frankfurter Ring 117, 80807 München,

Germany

LUFTPORT
PAR AVION
PRIORITAIRE